

EMS-EHL

Intel® Atom™ / Celeron Elkhart Lake Fanless Embedded
Moduler System

Quick Reference Guide

1st Ed –07 February 2023

Copyright Notice

Copyright © 2023 Avalue Technology Inc., ALL RIGHTS RESERVED.

FCC Statement



THIS DEVICE COMPLIES WITH PART 15 FCC RULES. OPERATION IS SUBJECT TO THE FOLLOWING TWO CONDITIONS:

(1) THIS DEVICE MAY NOT CAUSE HARMFUL INTERFERENCE.

(2) THIS DEVICE MUST ACCEPT ANY INTERFERENCE RECEIVED INCLUDING INTERFERENCE THAT MAY CAUSE UNDESIRE OPERATION.

THIS EQUIPMENT HAS BEEN TESTED AND FOUND TO COMPLY WITH THE LIMITS FOR A CLASS "A" DIGITAL DEVICE, PURSUANT TO PART 15 OF THE FCC RULES.

THESE LIMITS ARE DESIGNED TO PROVIDE REASONABLE PROTECTION AGAINST HARMFUL INTERFERENCE WHEN THE EQUIPMENT IS OPERATED IN A COMMERCIAL ENVIRONMENT. THIS EQUIPMENT GENERATES, USES, AND CAN RADIATE RADIO FREQUENCY ENERGY AND, IF NOT INSTALLED AND USED IN ACCORDANCE WITH THE INSTRUCTION MANUAL, MAY CAUSE HARMFUL INTERFERENCE TO RADIO COMMUNICATIONS.

OPERATION OF THIS EQUIPMENT IN A RESIDENTIAL AREA IS LIKELY TO CAUSE HARMFUL INTERFERENCE IN WHICH CASE THE USER WILL BE REQUIRED TO CORRECT THE INTERFERENCE AT HIS OWN EXPENSE.

A Message to the Customer

Avalue Customer Services

Each and every Avalue's product is built to the most exacting specifications to ensure reliable performance in the harsh and demanding conditions typical of industrial environments. Whether your new Avalue device is destined for the laboratory or the factory floor, you can be assured that your product will provide the reliability and ease of operation for which the name Avalue has come to be known.

Your satisfaction is our primary concern. Here is a guide to Avalue's customer services. To ensure you get the full benefit of our services, please follow the instructions below carefully.

Technical Support

We want you to get the maximum performance from your products. So if you run into technical difficulties, we are here to help. For the most frequently asked questions, you can easily find answers in your product documentation. These answers are normally a lot more detailed than the ones we can give over the phone. So please consult the user's manual first.

To receive the latest version of the user's manual; please visit our Web site at:

<http://www.avalue.com.tw/>

Content

1. Getting Started	6
1.1 Safety Precautions	6
1.2 Packing List	6
1.3 System Specifications	7
1.4 System Overview.....	13
1.4.1 Front View	13
1.4.2 Rear View.....	13
1.5 System Dimensions.....	21
1.5.1 Front & Top View	21
2. Hardware Configuration	22
2.1 EMS-EHL connector mapping	23
2.1.1 General purpose I/O connector (GPIO)	23
2.1.2 Serial Port 1/2 connector (COM1/2)	23
2.2 EBM-EHLS Overviews	24
2.3 EBM-EHLS Jumper & Connector list	25
2.4 EBM-EHLS Jumpers & Connectors settings	27
2.4.1 Multi-function select (SW1).....	27
2.4.2 Serial port 1/2 pin 9 signal select (JRI1/2)	27
2.4.3 Serial port 1/2 RS-232/422/485 mode select (JCOM_SEL1/2)	28
2.4.4 Clear CMOS (JBAT1)	28
2.4.5 eSPI connector (JESPI1).....	29
2.4.6 BIOS SPI connector (BIOS_SPI).....	29
2.4.7 Front Panel connector (JFP1).....	30
2.4.8 DC Output connector (DCOUT1).....	30
2.4.9 DC Input connector (JVIN1).....	31
2.4.10 EC Debug connector (JEC_ROM1).....	31
2.4.11 On-board header for USB2.0 (JUSB1).....	32
2.4.12 Power on/off connector (PWRBTN1)	32
2.4.13 IET connector (IET_CB1)	33
2.4.14 Battery connector (BATH2)	34
2.5 Installing Hard Disk & Memory (EMS-EHL)	35
3. BIOS Setup	36
3.1 Introduction.....	37
3.2 Starting Setup.....	37
3.3 Using Setup	38

EMS-EHL

3.4	Getting Help.....	39
3.5	In Case of Problems	39
3.6	BIOS setup	40
3.6.1	Main Menu	40
3.6.1.1	System Language	41
3.6.1.2	System Date	41
3.6.1.3	System Time	41
3.6.2	Advanced Menu	41
3.6.2.1	CPU Configuration	42
3.6.2.2	Power & Performance	43
3.6.2.2.1	CPU - Power Management Control.....	43
3.6.2.2.1.1	View/Configure Turbo Options.....	44
3.6.2.2.2	GT - Power Management Control	44
3.6.2.3	PCH-FW Configuration.....	45
3.6.2.3.1	Firmware Update Configuration	45
3.6.2.3.2	PTT Configuration	46
3.6.2.4	Trusted Computing.....	46
3.6.2.5	ACPI Settings	47
3.6.2.6	IT5571 Super IO Configuration	47
3.6.2.6.1	Serial Port 1 Configuration	49
3.6.2.6.2	Serial Port 2 Configuration	49
3.6.2.6.3	Serial Port 3 Configuration	50
3.6.2.6.4	Serial Port 4 Configuration	51
3.6.2.6.5	Serial Port 5 Configuration	52
3.6.2.6.6	Serial Port 6 Configuration	53
3.6.2.7	H/W Monitor	54
3.6.2.8	S5 RTC Wake Settings	54
3.6.2.9	Serial Port Console Redirection	55
3.6.2.10	USB Configuration.....	55
3.6.2.11	Network Stack Configuration.....	56
3.6.2.12	NVMe Configuration	57
3.6.2.13	Intel® Ethernet Controller I226-IT – 00:04:5F:96:CF:22	57
3.6.2.14	Intel® Ethernet Controller I226-IT – 00:04:5F:96:CF:23	58
3.6.2.15	Driver Health	58
3.6.3	Chipset.....	59
3.6.3.1	System Agent (SA) Configuration.....	59
3.6.3.1.1	Memory Configuration	60
3.6.3.1.2	Graphics Configuration.....	60
3.6.3.2	PCH-IO Configuration.....	61
3.6.3.2.1	PCI Express Configuration.....	61

3.6.3.2.1.1	PCI Express Root Port 3(LAN1-I225/I226)	62
3.6.3.2.1.2	PCI Express Root Port 4(LAN2-I225/I226)	63
3.6.3.2.1.3	PCI Express Root Port 5(M.2 KeyB/IET)	64
3.6.3.2.1.4	PCI Express Root Port 7(M.2 KeyE/IET)	65
3.6.3.2.2	SATA Configuration	66
3.6.3.2.3	USB Configuration	66
3.6.3.2.4	HD Audio Configuration	67
3.6.3.2	Board & Panel Configuration	67
3.6.4	Security	68
3.6.4.1	Secure Boot	69
3.6.4.1.1	Key Management	70
3.6.5	Boot	71
3.6.6	Save and exit	72
3.6.6.1	Save Changes and Reset	72
3.6.6.2	Discard Changes and Reset	72
3.6.6.3	Restore Defaults	73
4.	Drivers Installation	74
4.1	Install Chipset Driver	75
4.2	Install ME Driver	76
4.3	Install VGA Driver	77
4.4	Install Audio Driver (For Realtek ALC888S)	78
4.5	Install Ethernet Driver	79

1. Getting Started

1.1 Safety Precautions

Warning!



Always completely disconnect the power cord from your chassis whenever you work with the hardware. Do not make connections while the power is on. Sensitive electronic components can be damaged by sudden power surges. Only experienced electronics personnel should open the PC chassis.

Caution!



Always ground yourself to remove any static charge before touching the CPU card. Modern electronic devices are very sensitive to static electric charges. As a safety precaution, use a grounding wrist strap at all times. Place all electronic components in a static-dissipative surface or static-shielded bag when they are not in the chassis.

1.2 Packing List

- 1 x EMS-EHL Intel® Celeron®/ Atom® SoC Processor J6413/x6425E Fanless Rugged Embedded System
- 1 x Terminal block to lockable DC Jack cable
- 1 x DP to VGA Converter
- 1 x Screw driver for chassis
- 1 x Wire tie for HDMI
- 1 x 60W/120W adapter (optional)
- 1 x Power cord (optional)



If any of the above items is damaged or missing, contact your retailer.

1.3 System Specifications

System	
Board	<ul style="list-style-type: none"> EBM-EHLS (EMS-EHL) <p><u>With IET Extension Board</u></p> <ul style="list-style-type: none"> EBM-EHLS +AUX-M01 (EMS-EHL-6 COM) EBM-EHLS +IET-BYPASS (EMS-EHL-6 LAN Bypass) EBM-EHLS +IET-Normal LAN (EMS-EHL-6 LAN Normal) EBM-EHLS +IET-PSEBF (EMS-EHL-PSEBF), support 4 port IEEE 802.af EBM-EHLS +IET-PSEBT (EMS-EHL-PSEBT), support 2 port IEEE 802.at EBM-EHLS +AUX-M07 (EMS-EHL-4 COM Isolation) EBM-EHLS +EBM-BYTS DB-A (EMS-EHL-HDMI) EBM-EHLS +EBM-CDVS DB-A (EMS-EHL-DVI) EBM-EHLS +EBM-BYTS DB-E (EMS-EHL-USB)
CPU	<ul style="list-style-type: none"> Intel® Celeron® Processor J6413 (1.5M Cache, up to 3.00Ghz), ST, T_j=105°C Intel® ATOM® Processor X6425E(1.5M Cache, up to 3.00Ghz), WT, T_j=-40°C ~105°C
SBC	<ul style="list-style-type: none"> 5.25" SBC
BIOS	<ul style="list-style-type: none"> AMI uEFI BIOS 256 Mbit SPI Flash ROM
System Chipset	<ul style="list-style-type: none"> SoC
I/O Chip	<ul style="list-style-type: none"> EC ITE IT5571
System Memory	<ul style="list-style-type: none"> 1 x 260-pin SODIMM socket Max. Up to 32GB DDR4 3200 MT/s
Watchdog Timer	<ul style="list-style-type: none"> H/W Reset, 1sec. ~ 65535sec.
Battery	<ul style="list-style-type: none"> Cable type Supports wide operating temperature (adjusting according to test result) Supports no RTC battery mode
H/W Status Monitor	<ul style="list-style-type: none"> CPU & system temperature monitoring and Voltages monitoring
TPM	<ul style="list-style-type: none"> TPM 2.0, NuvoTon NPCT754AADYX, PN: E14S4075401H, co-lay SLB9670VQ2.0: E14S4967000H
Expansion	
Expansion	<ul style="list-style-type: none"> 1 x M.2 Key-B 2242/3042/3052 support SATA3/ PCIe III/ USB3.2 Gen.1 and SIM slot1 (internal), default support 3.3V, jumper setting to adjust 3.3V/ 3.8V 1 x M.2 Key-E 2230 for Wi-Fi & BT Module (USB2.0/ PCIe III) 1 x IET interface (1 x DDI, 4x PCIeIII x1, 3 x USB2.0, 1 x Line-Out(R/L), 1 x SMBus, LPC)
Storage	

EMS-EHL

Combination	<ul style="list-style-type: none"> ● 1 x M.2 Key-B 2242/2280, support SATA ● 1 x M.2 Key-B 2242, support SATA (share with expansion slot)
Front Edge I/O	
Button	<ul style="list-style-type: none"> ● 1 x Push Button for Power on/off ● 1 x Push Button for Reset ● 1 x 2-Pin Terminal Block for wire-control power on/off
LED	<ul style="list-style-type: none"> ● 1 x Power LED (Blue) ● 1 x Storage LED (Yellow)- M.2 B-key SATA ● 1 x LTE LED (Green)- M.2 B-key PCIe ● 1 x Wifi LED (Green)- M.2 E key
Serial Port	<ul style="list-style-type: none"> ● 2 x COM RS232/422/485 (select via BIOS, auto flow control via HW)
GPIO	<ul style="list-style-type: none"> ● 1 x 8-bit GPIO (DB9)
Antenna	<ul style="list-style-type: none"> ● 2 x Antennas
Rear Edge I/O	
USB Port	<p>EMS-EHL</p> <ul style="list-style-type: none"> ● 2 x USB 3.1 Gen.2 (10Gbp/s) ● 2 x USB 3.1 Gen.1 (5Gbp/s), via USB Hub <p>EMS-EHL-HDMI, EMS-EHL-DVI, EMS-EHL-6COM, EMS-EHL-4COM isolation, EMS-EHL-PSEBF, EMS-EHL-PSEBT, EMS-EHL-6 LAN Bypass, EMS-EHL 6 LAN Normal</p> <ul style="list-style-type: none"> ● 2 x USB 3.1 Gen.2 (10Gbp/s) ● 2 x USB 3.1 Gen.1 (5Gbp/s) via Hub ● 2 x USB 2.0 <p>EMS-EHL-USB</p> <ul style="list-style-type: none"> ● 2 x USB 3.1 Gen.2 (10Gbp/s) ● 6 x USB 3.1 Gen.1 (5Gbp/s) via Hub ● 3 x USB 2.0
LAN	<p>EMS-EHL, EMS-EHL-DVI, EMS-EHL-6COM, EMS-EHL-4 COM isolation, EMS-EHL-USB</p> <ul style="list-style-type: none"> ● 2 x RJ45 <p>EMS-EHL-HDMI</p> <ul style="list-style-type: none"> ● 4 x RJ45 <p>EMS-EHL-PSEBT</p> <ul style="list-style-type: none"> ● 4 x RJ45, 2 port Powered LAN support IEEE802.at <p>EMS-EHL-PSEBF</p>

	<ul style="list-style-type: none"> ● 6 x RJ45, 4 port Powered LAN support IEEE802.af <p>EMS-EHL-6 LAN Bypass, EMS-EHL 6 LAN Normal</p> <ul style="list-style-type: none"> ● 6 x RJ45
Serial Port	<p>EMS-EHL-HDMI</p> <ul style="list-style-type: none"> ● 2 x COM RS232/422/485 (select via BIOS, auto flow control via HW) <p>EMS-EHL-6COM</p> <ul style="list-style-type: none"> ● 4 x COM RS232/422/485 (select via BIOS, auto flow control via HW) <p>EMS-EHL-4COM isolation</p> <ul style="list-style-type: none"> ● 4 x COM RS232/422/485 (select via BIOS, auto flow control via HW), supported 2.5kv Isolation.
Audio	<ul style="list-style-type: none"> ● 1 x Mic-In, 1 x Line-Out
Display	<p>EMS-EHL, EMS-EHL-6COM, EMS-EHL-4COM isolation, EMS-EHL-PSEBF, EMS-EHL-PSEBT, EMS-EHL-6 LAN Bypass, EMS-EHL 6 LAN Normal, EMS-EHL-USB</p> <ul style="list-style-type: none"> ● 1x DP++ 1.4 (DP to VGA converter is the standard accessory, and optional DP to DVI, DP to HDMI converters) ● 1x HDMI 2.0b <p>EMS-EHL-DVI</p> <ul style="list-style-type: none"> ● 1 x DP++ 1.4 (DP to VGA converter is the standard accessory, and optional DP to DVI, DP to HDMI converters) ● 1 x HDMI 2.0b ● 1 x DVI-D <p>EMS-EHL-HDMI</p> <ul style="list-style-type: none"> ● 1 x DP++ 1.4 (DP to VGA converter is the standard accessory, and optional DP to DVI, DP to HDMI converters) ● 2 x HDMI 2.0b
Power connector	<ul style="list-style-type: none"> ● 1 x 3-pin Phoenix connector
Antenna	<ul style="list-style-type: none"> ● 2 x Antennas
Side IO	
Antenna	<ul style="list-style-type: none"> ● 4 x Antennas
Internal IO	
SIM slot	<ul style="list-style-type: none"> ● 1 x internal SIM slot

EMS-EHL

DC out	<ul style="list-style-type: none"> 1 x 6 pin DC out (12V/6A) 																				
IET connector	<ul style="list-style-type: none"> 1 x 80 pin IET connector 																				
USB pin header	<ul style="list-style-type: none"> 1 x USB 2.0 																				
Display																					
Chipset	<ul style="list-style-type: none"> Intel® UHD Graphics for 10th Gen Intel® Processors 																				
Resolution	<ul style="list-style-type: none"> DP++ 1.4: 4096x2304 @ 60Hz HDMI 2.0b : Max. resolution 4096x2304 @ 60Hz * DP to HDMI cable cannot support 4K @ 60Hz, Max up to 1920x1080 (60Hz) DVI-D (Dual Link): 2560x1600 @ 60Hz 																				
Multiple Display	<ul style="list-style-type: none"> 2 displays 3 displays (EMS-EHL-DVI, EMS-EHL-HDMI) 																				
Ethernet																					
Chipset	Standard Sku: <ul style="list-style-type: none"> 2 x Intel I226-IT 																				
Ethernet Interface	Standard Sku: <ul style="list-style-type: none"> 2x 10/100/1000/2.5G Base-Tx GbE compatible 																				
LED Signal	2.5G LAN Port (i226-IT) <table border="1" data-bbox="486 1021 1318 1276"> <thead> <tr> <th colspan="2">ACT/LINK</th> <th colspan="2">SPEED</th> </tr> <tr> <th>LED</th> <th>Definition</th> <th>LED</th> <th>Definition</th> </tr> </thead> <tbody> <tr> <td>Light Off</td> <td>No Link</td> <td>Solid Orange</td> <td>2.5G</td> </tr> <tr> <td>Solid Yellow</td> <td>Connection</td> <td>Solid Green</td> <td>1G/100M</td> </tr> <tr> <td>Flashing</td> <td>Activity</td> <td>Light Off</td> <td>10M</td> </tr> </tbody> </table>	ACT/LINK		SPEED		LED	Definition	LED	Definition	Light Off	No Link	Solid Orange	2.5G	Solid Yellow	Connection	Solid Green	1G/100M	Flashing	Activity	Light Off	10M
ACT/LINK		SPEED																			
LED	Definition	LED	Definition																		
Light Off	No Link	Solid Orange	2.5G																		
Solid Yellow	Connection	Solid Green	1G/100M																		
Flashing	Activity	Light Off	10M																		
Audio																					
Chipset	<ul style="list-style-type: none"> Realtek ALC888S (co-lay with ALC897) HD codec 																				
Audio Interface	<ul style="list-style-type: none"> Mic-In, Line-Out 																				
Mechanical & Environmental																					
Power Connector	<ul style="list-style-type: none"> 3-Pin Terminal Block (V+, V-, GND) 																				
Power Requirement	<ul style="list-style-type: none"> DC in typical 12/24V (+9V ~ +32V), wide voltage single power input TVS component for surge protection Reverse current/voltage protection(Max. Currency: 13A) 																				
Power Type	<ul style="list-style-type: none"> AT/ATX (ATX is default setting) 																				
ACPI	<ul style="list-style-type: none"> Single power ATX Support S0, S3, S4, S5 ACPI 5.0 Compliant 																				
Dimension (W x L x H)	<ul style="list-style-type: none"> 240mm x 150mm x 43 mm (Standard) 240mm x 150mm x 64 mm (w/ IET module) 																				
Weight	<ul style="list-style-type: none"> 1910 g 																				
Color	<ul style="list-style-type: none"> Avalue Box PC family design 																				
Mounting Kit	<ul style="list-style-type: none"> Wall mount kit (standard) 																				

	<ul style="list-style-type: none"> ● DIN RAIL (optional)
Reliability	
Vibration Test (operation)	<ol style="list-style-type: none"> 1. PSD: 0.0505G²/Hz , 5 Grms 2. Operation mode 3. Test Frequency : 5-500Hz 4. Test Axis : X,Y and Z axis 5. 30 minutes per each axis 6. IEC 60068-2-64 Test:Fh 7. Storage : SSD
Vibration Test (non-operation)	<ol style="list-style-type: none"> 1. Test Acceleration : 2G 2. Test frequency : 5~500 Hz 3. Sweep : 1 Oct/ per one minute. (logarithmic) 4. Test Axis : X,Y and Z axis Test time :30 min. each axis 5. System condition : Non-Operating mode 6. Reference IEC 60068-2-6 Testing procedures
Package vibration test	<ol style="list-style-type: none"> 1. PSD: 0.026G²/Hz , 2.16 Grms 2. Non-operation mode 3. Test Frequency : 5-500Hz 4. Test Axis : X,Y and Z axis 5. 30 min. per each axis 6. IEC 60068-2-64 Test:Fh
Shock	<ol style="list-style-type: none"> 1. Wave form : Half Sine wave 2. Acceleration Rate : 55g for operation mode 3. Duration Time : 11ms 4. No. of Shock : +/- XYZ axis 18 times 5. Operation mode 6. Reference IEC 60068-2-27 Testing procedures Test Eb : Shock Test
Package Drop Test	<ol style="list-style-type: none"> 1. One corner , three edges, six faces 2. ISTA 2A, IEC-60068-2-32 Test:Ed
IP	<ul style="list-style-type: none"> ● IP 50
Operating Temperature	<ul style="list-style-type: none"> ● -40°C ~ 70°C (w/SSD) ambient w/ 0.5 air flow, WT sku, X6425E ● -40°C ~ 60°C (w/SSD) ambient w/ 0.2 air flow, WT sku, X6425E ● 0°C ~ 65°C (w/SSD) ambient w/ 0.5 air flow, ST sku, J6413 ● 0°C ~ 55°C (w/SSD) ambient w/ 0.2 air flow, ST sku, J6413
Operating Humidity	<ul style="list-style-type: none"> ● 40°C @ 95% Relative Humidity, Non-condensing
Storage Temperature	<ul style="list-style-type: none"> ● -30°C ~ 70°C (-22°F ~ 158°F)
Certification	<ul style="list-style-type: none"> ● CE, FCC Class B, LVD 62368-1
OS Supported	<ul style="list-style-type: none"> ● Win 10 64bit / Win 11 64 bit/ Linux
Compliant with following Flexible IET Expansion Modules (Optional)	

EMS-EHL

IET-6 LAN BYPASSB	<ul style="list-style-type: none">● 4 x LAN support 2-Pair LAN bypass + 2 x USB 2.0
IET-6 LAN Normal	<ul style="list-style-type: none">● 4 x normal LAN + 2 x USB 2.0
IET-PSEBF (4 port at)	<ul style="list-style-type: none">● 4 x LAN support PoE 802.3af + 2 x USB 2.0
IET-PSEBT (2 port at)	<ul style="list-style-type: none">● 2 x LAN support PoE 802.3at + 2 x USB 2.0
EBM-CDVS DB-A	<ul style="list-style-type: none">● 1 x DVI-D + 2 x USB 2.0
EBM-BYTS DB-E	<ul style="list-style-type: none">● 4 x USB 3.0 + 3 x USB 2.0
EBM-BYTS DB-A	<ul style="list-style-type: none">● 1 x HDMI, 2 x RJ45, 2 x RS-232/422/485 (BIOS), 2 x USB 2.0
AUX-M01	<ul style="list-style-type: none">● 4 x RS-232/422/485(BIOS), 2 x USB 2.0
AUX-M07	<ul style="list-style-type: none">● 4 x RS-232/422/485(BIOS) w/ 2.5KV isolation, 2 x USB 2.0



Note: Specifications are subject to change without notice.

1.4 System Overview

1.4.1 Front View

EMS-EHL

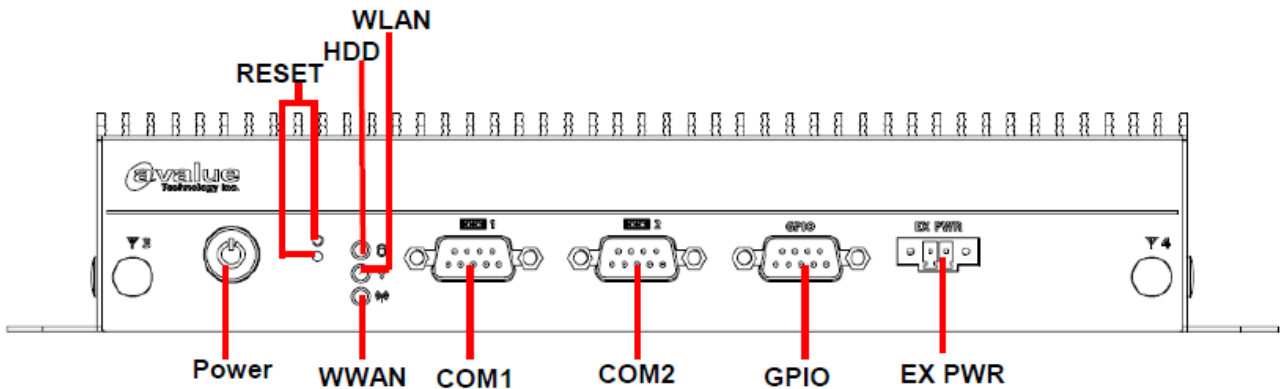

**EMS-EHL-6 COM/EMS-EHL-6 LAN Bypass/EMS-EHL-6 LAN Normal
/EMS-EHL-PSEBF/EMS-EHL-PSEBT/EMS-EHL-4 COM Isolation
/EMS-EHL-HDMI/EMS-EHL-DVI/EMS-EHL-USB**

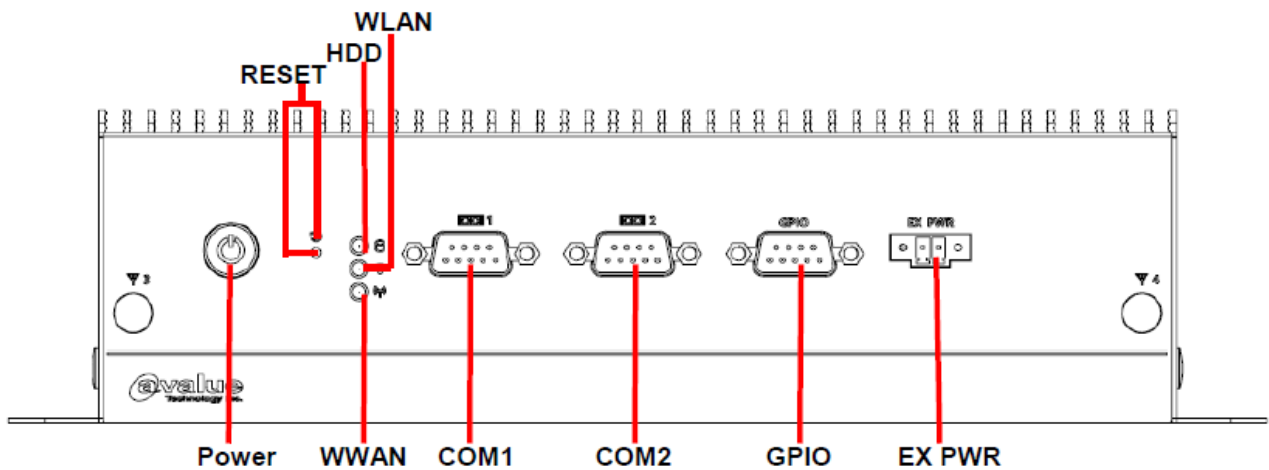

1.4.2 Rear View

EMS-EHL

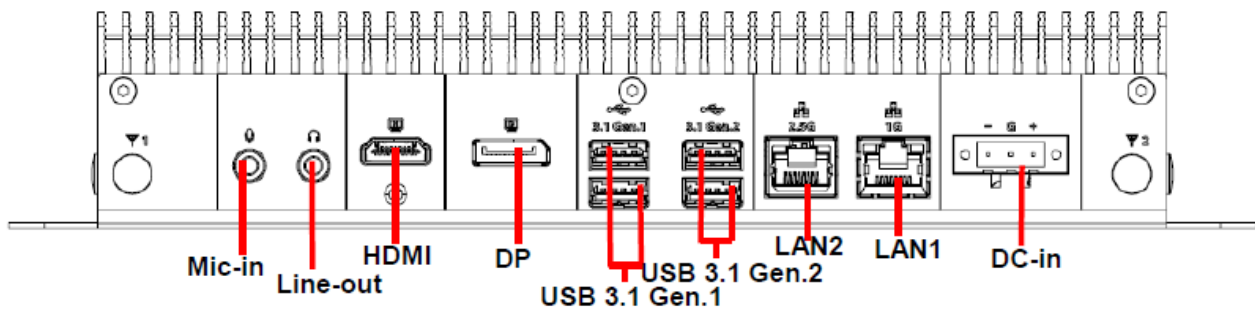

EMS-EHL-6 COM/EMS-EHL-4 COM Isolation

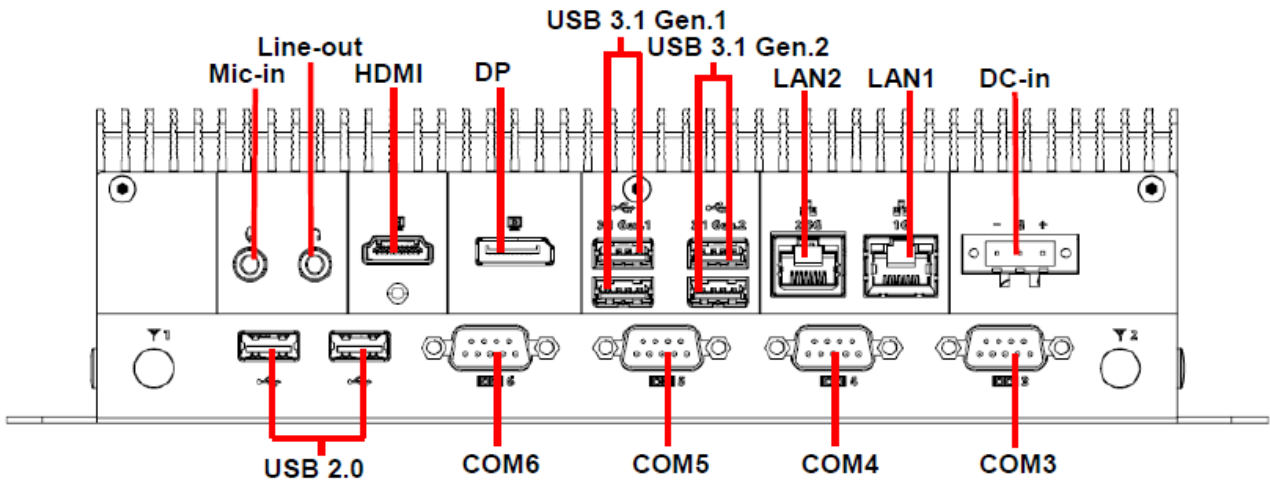

EMS-EHL-6 LAN Bypass/EMS-EHL-6 LAN Normal/EMS-EHL-PSEBF

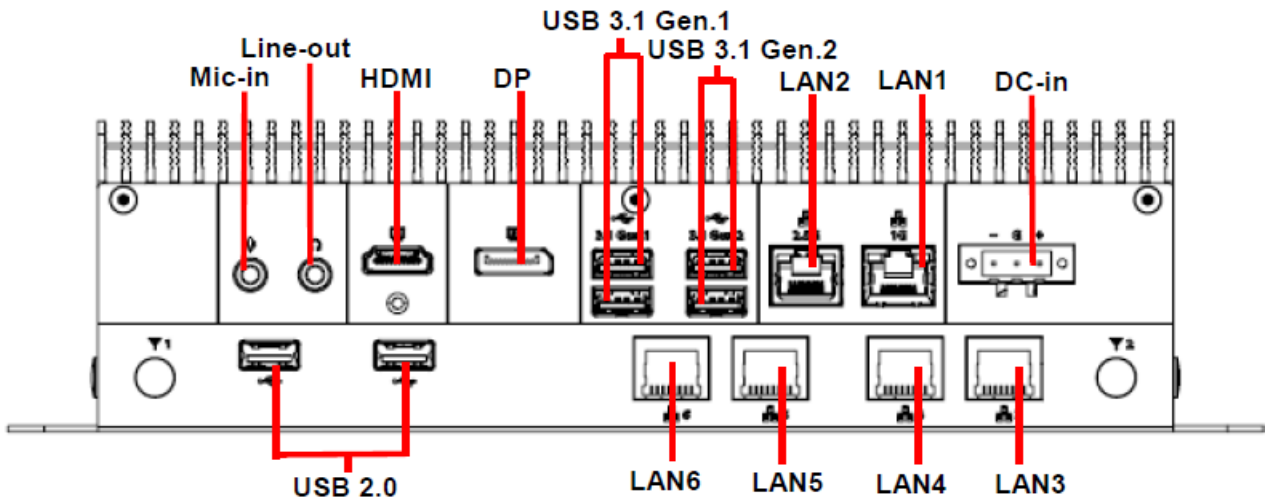

EMS-EHL-PSEBT

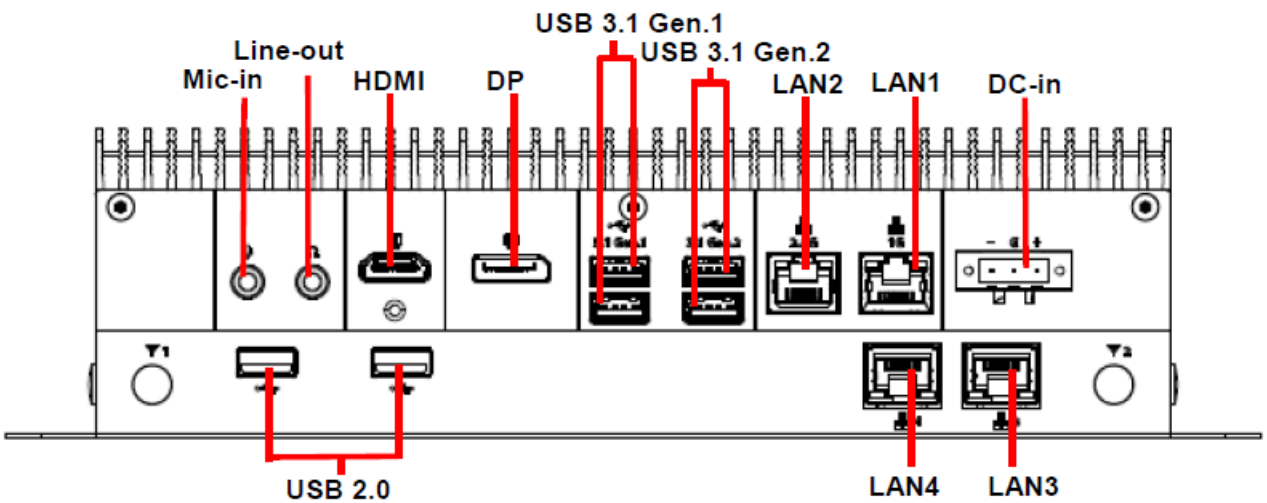

EMS-EHL-HDMI

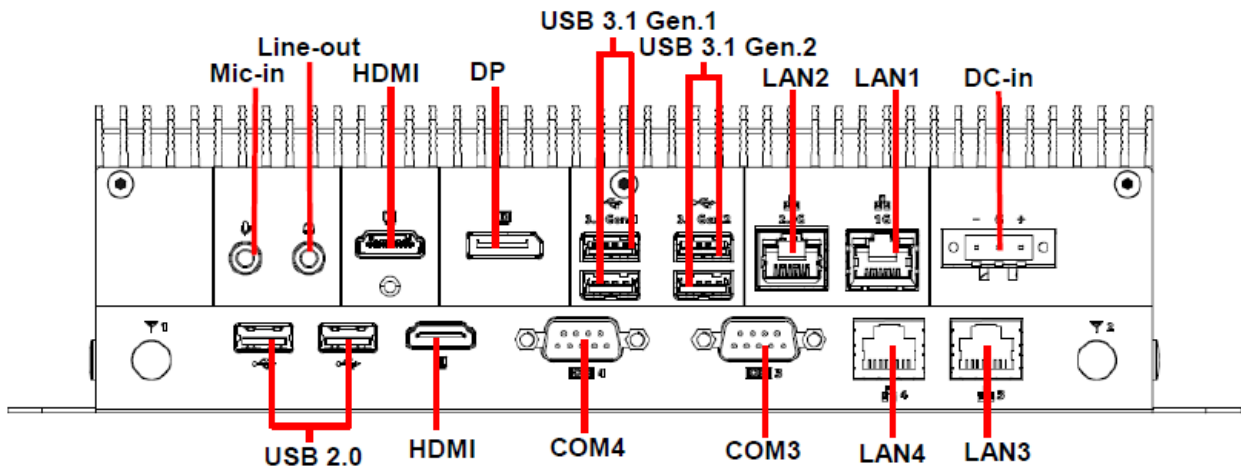

EMS-EHL-DVI

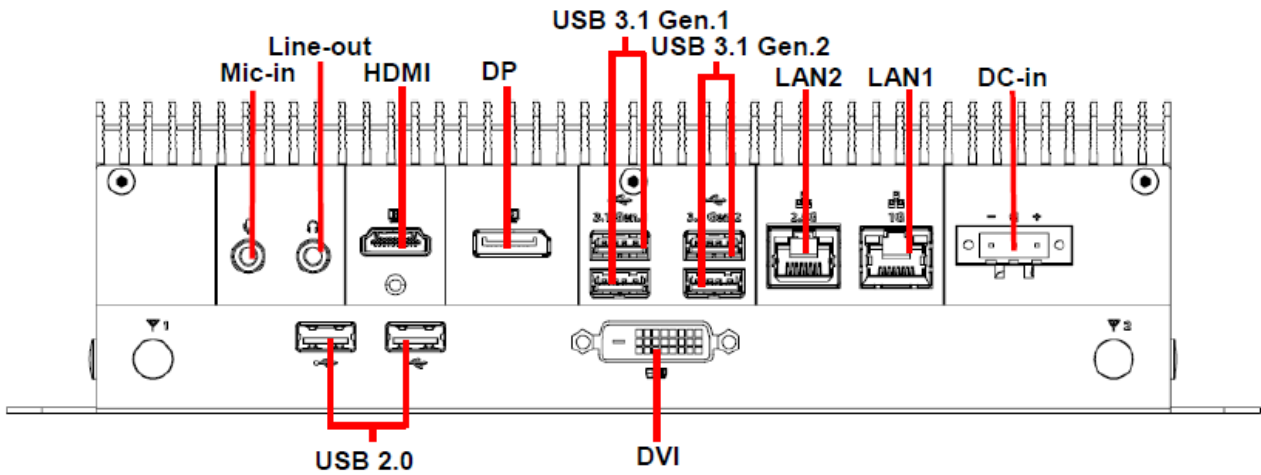

EMS-EHL-USB

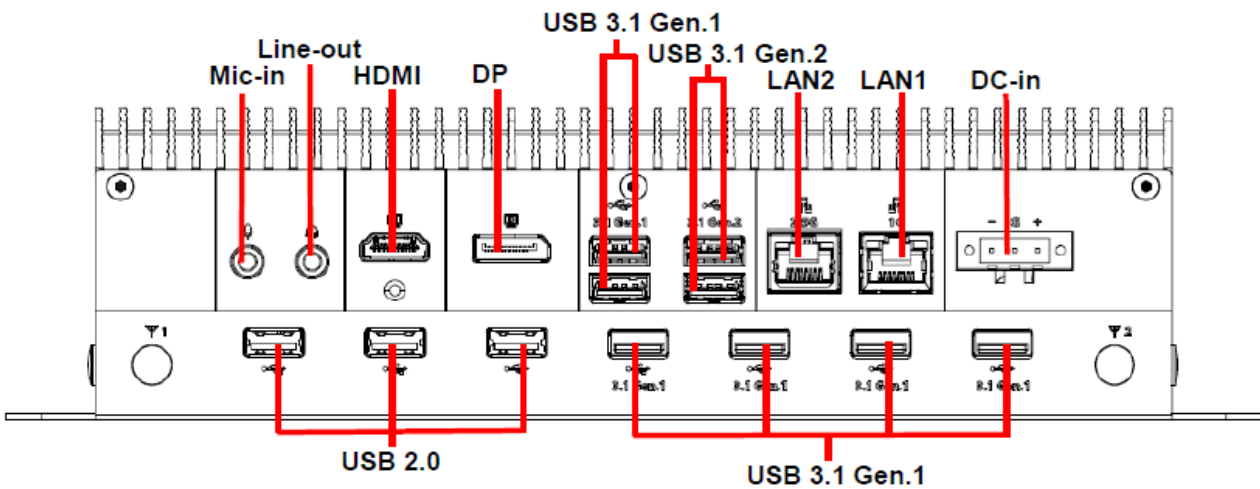

EMS-EHL

EMS-EHL

Connectors

Label	Function	Note
Power	System power indicator	
Reset	Reset button	
HDD	HDD indicator	
WWAN	WWAN Indicator	
WLAN	WLAN Indicator	
COM1/2	Serial port connector 1/2	
GPIO	General purpose I/O connector	
EX PWR	Power on button	
Mic-in	Mic-in audio jack	
Line-out	Line-out jack	
HDMI	HDMI connector	
DP	DP connector	
USB 3.1 Gen.1	2 x USB 3.1 Gen.1 connector	
USB 3.1 Gen.2	2 x USB 3.1 Gen.2 connector	
LAN1/2	RJ-45 Ethernet 1/2	
DC-in	DC power-in connector	

EMS-EHL-6 COM/EMS-EHL-4 COM Isolation

Connectors

Label	Function	Note
Power	System power indicator	
Reset	Reset button	
HDD	HDD indicator	
WWAN	WWAN Indicator	
WLAN	WLAN Indicator	
COM1/2/3/4/5/6	Serial port connector 1/2/3/4/5/6	
GPIO	General purpose I/O connector	
EX PWR	Power on button	
Mic-in	Mic-in audio jack	
Line-out	Line-out jack	
HDMI	HDMI connector	
DP	DP connector	
USB 3.1 Gen.1	2 x USB 3.1 Gen.1 connector	

USB 3.1 Gen.2	2 x USB 3.1 Gen.2 connector
USB 2.0	2 x USB 2.0 connector
LAN1/2	RJ-45 Ethernet 1/2
DC-in	DC power-in connector

EMS-EHL-6 LAN Bypass/EMS-EHL-6 LAN Normal/EMS-EHL-PSEBF

Connectors

Label	Function	Note
Power	System power indicator	
Reset	Reset button	
HDD	HDD indicator	
WWAN	WWAN Indicator	
WLAN	WLAN Indicator	
COM1/2	Serial port connector 1/2	
GPIO	General purpose I/O connector	
EX PWR	Power on button	
Mic-in	Mic-in audio jack	
Line-out	Line-out jack	
HDMI	HDMI connector	
DP	DP connector	
USB 3.1 Gen.1	2 x USB 3.1 Gen.1 connector	
USB 3.1 Gen.2	2 x USB 3.1 Gen.2 connector	
USB 2.0	2 x USB 2.0 connector	
LAN1/2/3/4/5/6	RJ-45 Ethernet 1/2/3/4/5/6	
DC-in	DC power-in connector	

EMS-EHL-PSEBT

Connectors

Label	Function	Note
Power	System power indicator	
Reset	Reset button	
HDD	HDD indicator	
WWAN	WWAN Indicator	
WLAN	WLAN Indicator	
COM1/2	Serial port connector 1/2	
GPIO	General purpose I/O connector	

EMS-EHL

EX PWR	Power on button
Mic-in	Mic-in audio jack
Line-out	Line-out jack
HDMI	HDMI connector
DP	DP connector
USB 3.1 Gen.1	2 x USB 3.1 Gen.1 connector
USB 3.1 Gen.2	2 x USB 3.1 Gen.2 connector
USB 2.0	2 x USB 2.0 connector
LAN1/2/3/4	RJ-45 Ethernet 1/2/3/4
DC-in	DC power-in connector

EMS-EHL-HDMI

Connectors

Label	Function	Note
Power	System power indicator	
Reset	Reset button	
HDD	HDD indicator	
WWAN	WWAN Indicator	
WLAN	WLAN Indicator	
COM1/2/3/4	Serial port connector 1/2/3/4	
GPIO	General purpose I/O connector	
EX PWR	Power on button	
Mic-in	Mic-in audio jack	
Line-out	Line-out jack	
HDMI	2 x HDMI connector	
DP	DP connector	
USB 3.1 Gen.1	2 x USB 3.1 Gen.1 connector	
USB 3.1 Gen.2	2 x USB 3.1 Gen.2 connector	
USB 2.0	2 x USB 2.0 connector	
LAN1/2/3/4	RJ-45 Ethernet 1/2/3/4	
DC-in	DC power-in connector	

EMS-EHL-DVI

Connectors

Label	Function	Note
Power	System power indicator	

Reset	Reset button
HDD	HDD indicator
WWAN	WWAN Indicator
WLAN	WLAN Indicator
COM1/2	Serial port connector 1/2
GPIO	General purpose I/O connector
EX PWR	Power on button
Mic-in	Mic-in audio jack
Line-out	Line-out jack
HDMI	HDMI connector
DP	DP connector
DVI	DVI connector
USB 3.1 Gen.1	2 x USB 3.1 Gen.1 connector
USB 3.1 Gen.2	2 x USB 3.1 Gen.2 connector
USB 2.0	2 x USB 2.0 connector
LAN1/2	RJ-45 Ethernet 1/2
DC-in	DC power-in connector

EMS-EHL-USB

Connectors

Label	Function	Note
Power	System power indicator	
Reset	Reset button	
HDD	HDD indicator	
WWAN	WWAN Indicator	
WLAN	WLAN Indicator	
COM1/2	Serial port connector 1/2	
GPIO	General purpose I/O connector	
EX PWR	Power on button	
Mic-in	Mic-in audio jack	
Line-out	Line-out jack	
HDMI	HDMI connector	
DP	DP connector	
USB 3.1 Gen.1	6 x USB 3.1 Gen.1 connector	
USB 3.1 Gen.2	2 x USB 3.1 Gen.2 connector	
USB 2.0	3 x USB 2.0 connector	

EMS-EHL

LAN1/2	RJ-45 Ethernet 1/2
DC-in	DC power-in connector

1.5 System Dimensions

1.5.1 Front & Top View

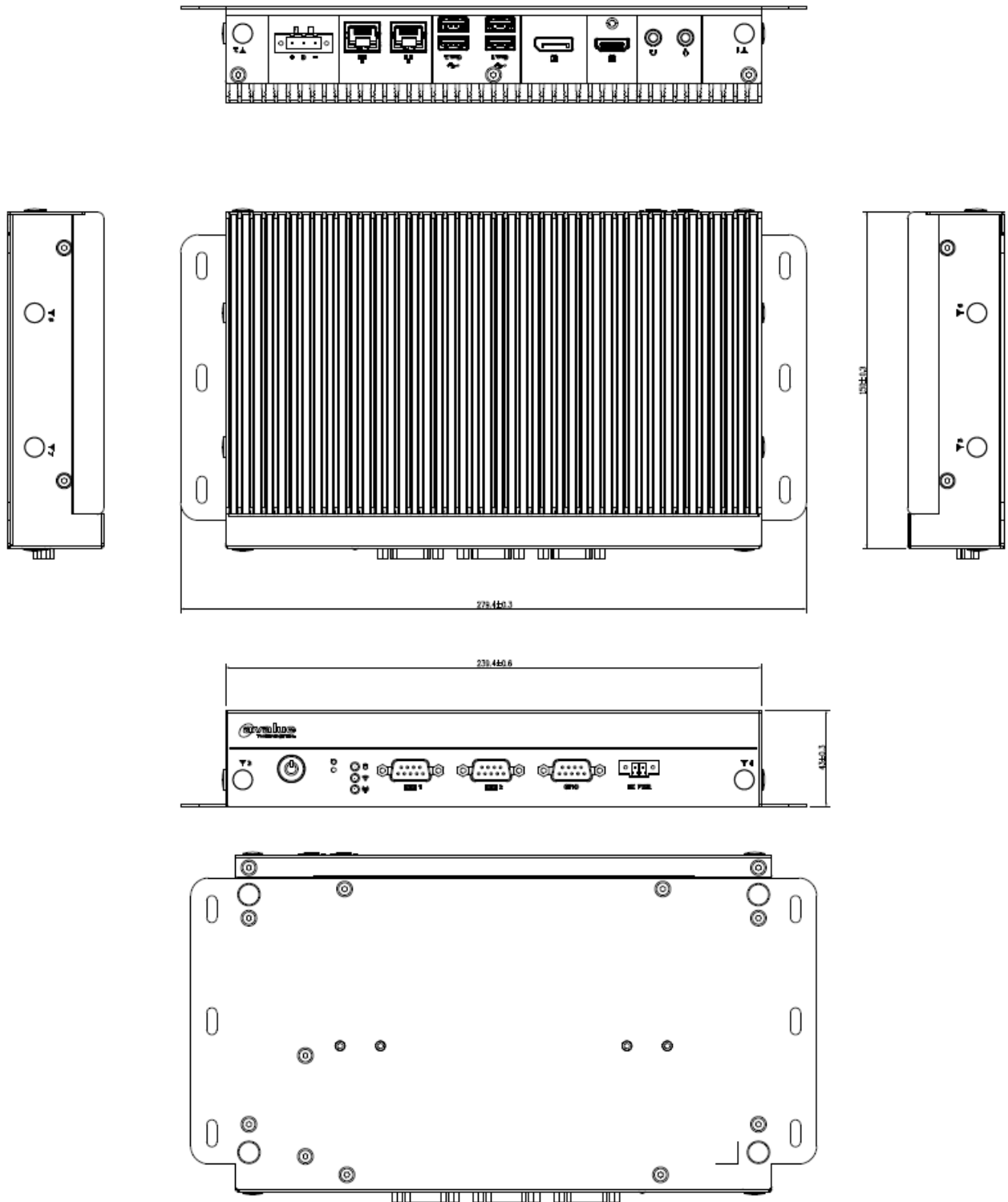

(Unit: mm)

2. Hardware Configuration

Jumper and Connector Setting, Driver and BIOS Installing

For advanced information, please refer to:

- 1- EBM-EHLS included in this manual.



Note: If you need more information, please visit our website:

<http://www.avalue.com.tw>

2.1 EMS-EHL connector mapping

2.1.1 General purpose I/O connector (GPIO)

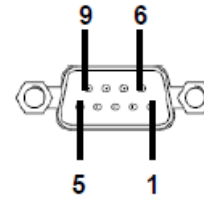
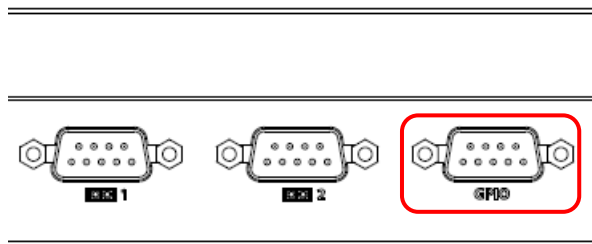

Signal	PIN	PIN	Signal
DIO_GP20	1	6	DIO_GP10
DIO_GP21	2	7	DIO_GP11
DIO_GP22	3	8	DIO_GP12
DIO_GP23	4	9	DIO_GP13
GND	5		

2.1.2 Serial Port 1/2 connector (COM1/2)

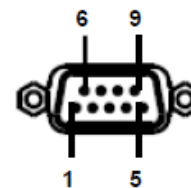
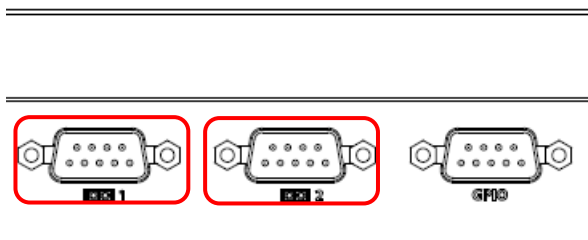

In RS-232 Mode

Signal	PIN	PIN	Signal
NDCD#	1	6	NDSR#
NRXD	2	7	NRTS#
NTXD	3	8	NCTS#
NDTR#	4	9	NRI#
GND	5		

In RS-422 Mode

Signal	PIN	PIN	Signal
TxD1-	1	6	NC
TxD1+	2	7	NC
RxD1+	3	8	NC
RxD1-	4	9	NC
GND	5		

In RS-485 Mode

Signal	PIN	PIN	Signal
DATA1-	1	6	NC
DATA1+	2	7	NC
NC	3	8	NC
NC	4	9	NC
GND	5		

2.2 EBM-EHLS Overviews

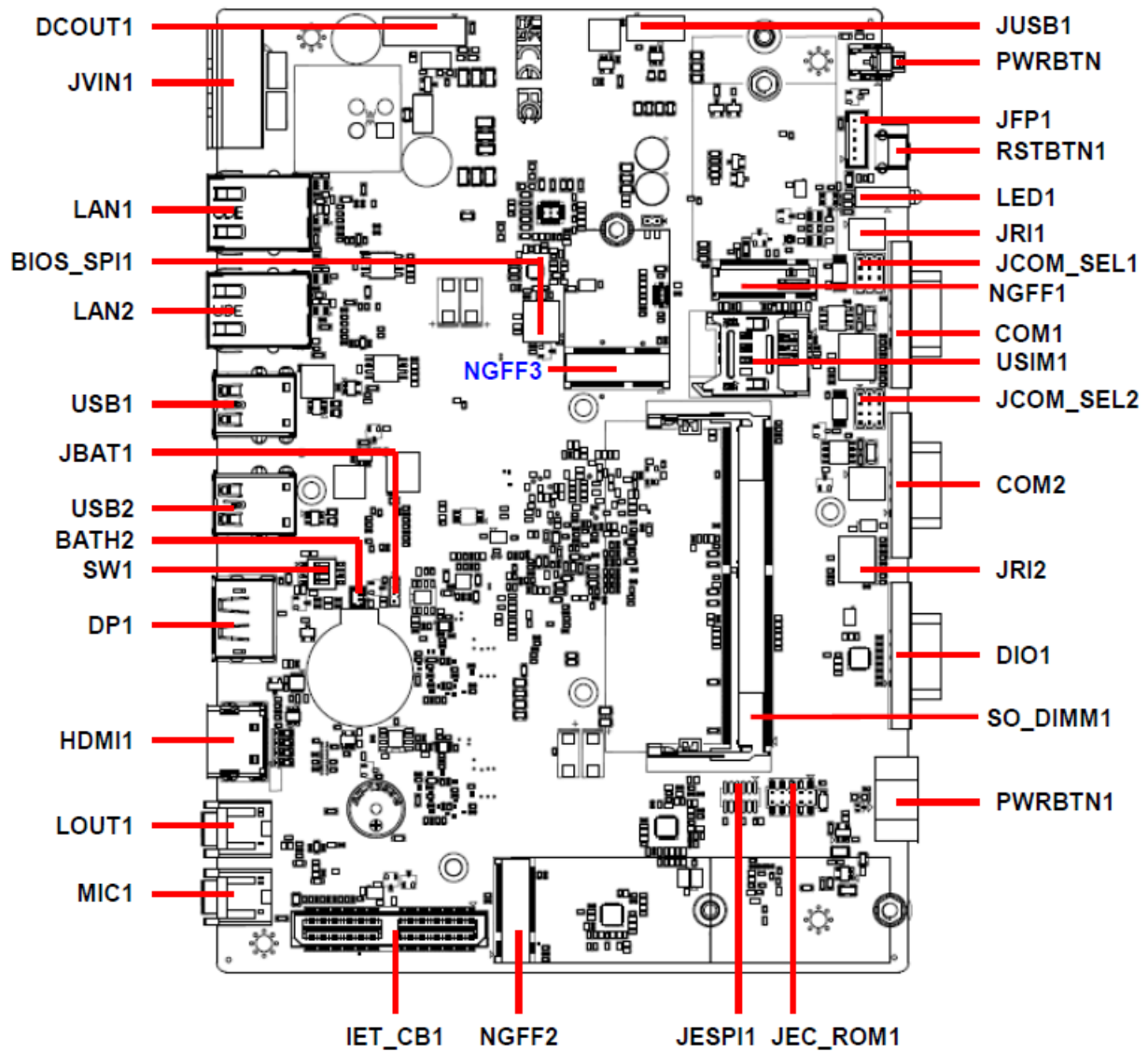

2.3 EBM-EHLS Jumper & Connector list

Jumpers

Label	Function	Note
JBAT1	Clear CMOS	3 x 1 header, pitch 2.00 mm
JRI1/2	Serial port 1/2 pin 9 signal select	3 x 2 header, pitch 2.00 mm
JCOM_SEL1/2	Serial port 1/2 – RS232/422/485 mode select	4 x 3 header, pitch 2.00 mm
SW1	Multi-function select	DIP switch 4pin

Connectors

Label	Function	Note
USB1	2 x USB3.1 Gen.2 connector	
USB2	2 x USB3.1 Gen.1 connector	
JUSB1	On-board header for USB2.0	5 x 2 wafer, pitch 2.00 mm
DIO1	General purpose I/O connector	
LAN1/2	RJ-45 Ethernet 1/2	
LOUT1	Audio line-out connector	
MIC1	Audio mic-in connector	
COM1/2	Serial port connector 1/2	
USIM1	SIM card slot	
JFP1	Front Panel connector	5 x 1 wafer, pitch 2.00 mm
PWRBTN1	Power on/off connector	1 x 2 terminal block, pitch 3.50 mm
PWRBTN	Power on/off button	
RSTBTN1	Reset button	
LED1	WWAN · WIFI & Storage	
HDMI1	HDMI connector	
SO_DIMM1	DDR4 SODIMM connector	
IET_CB1	IET connector	40 x 2 wafer, pitch 0.80mm
BIOS_SPI1	BIOS SPI connector	4 x 2 header, pitch 2.00 mm
JESPI1	eSPI connector	6 x 2 header, pitch 1.27 mm
DP1	DP connector	
NGFF1	M.2 Key-B 2242/3042/3052 connector	
NGFF2	M.2 KEY-B 2242/2280 connector	

EMS-EHL

NGFF3	M.2 KEY-E 2230 connector	
DCOUT1	DC Output connector	6 x 1 wafer, pitch 2.50 mm
JVIN1	DC Input connector	1 x 3 terminal block, pitch 5.08 mm
JEC_ROM1	EC Debug connector	5 x 2 header, pitch 2.00 mm
BATH2	Battery connector	2 x 1 wafer, pitch 1.25 mm

2.4 EBM-EHLS Jumpers & Connectors settings

2.4.1 Multi-function select (SW1)

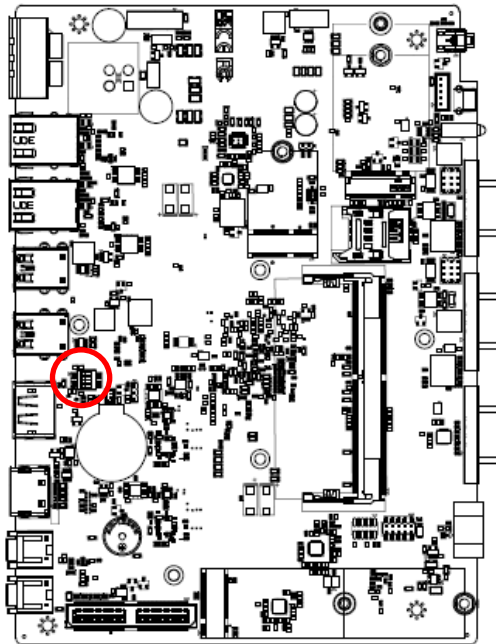

Power mode

	AT	ATX*
1	ON	OFF

DDI2 mode(DP+)

	DisplayPort*	HDMI	Cable select
2	OFF	OFF	ON
3	ON	OFF	OFF

N.C.

	WWAN	SSD
4	ON	OFF

2.4.2 Serial port 1/2 pin 9 signal select (JR11/2)

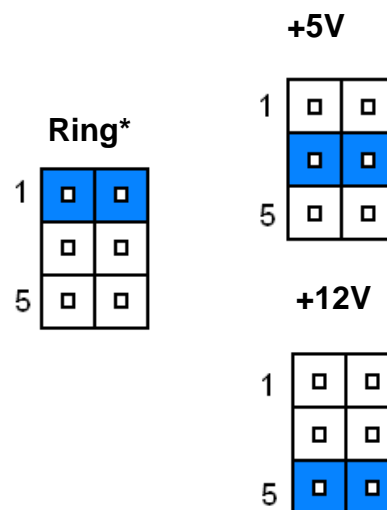
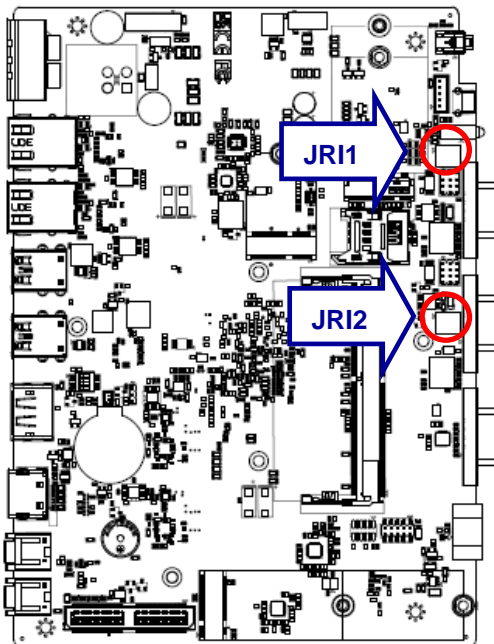

* Default

2.4.3 Serial port 1/2 RS-232/422/485 mode select (JCOM_SEL1/2)

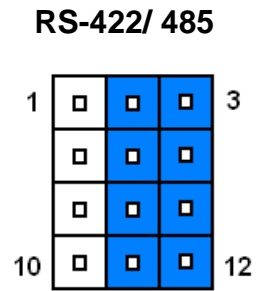
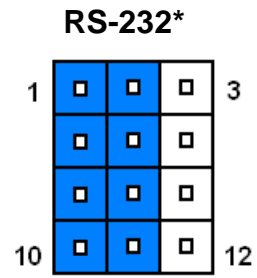
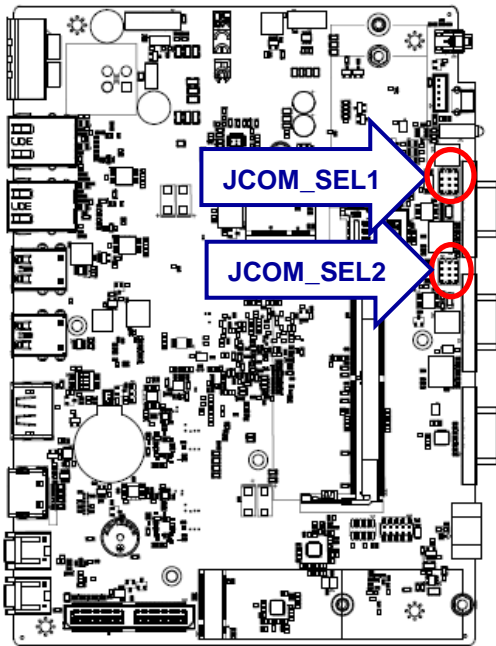

*Default

2.4.4 Clear CMOS (JBAT1)

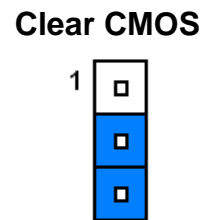
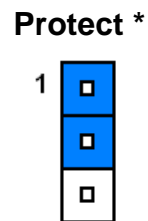
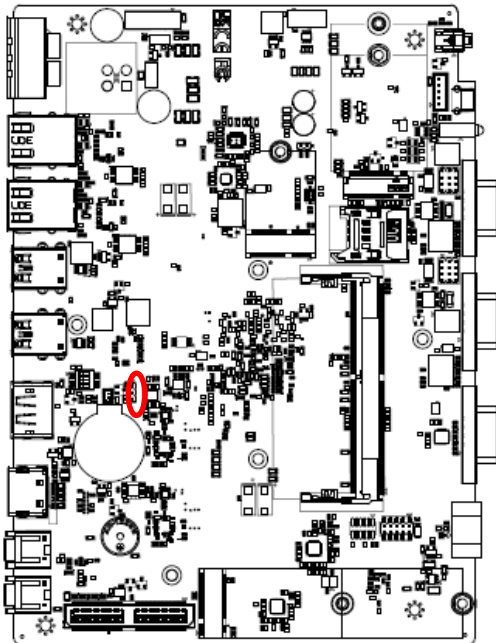

*Default

2.4.5 eSPI connector (JESPI1)

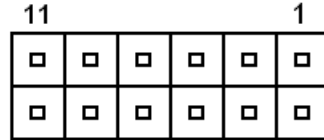
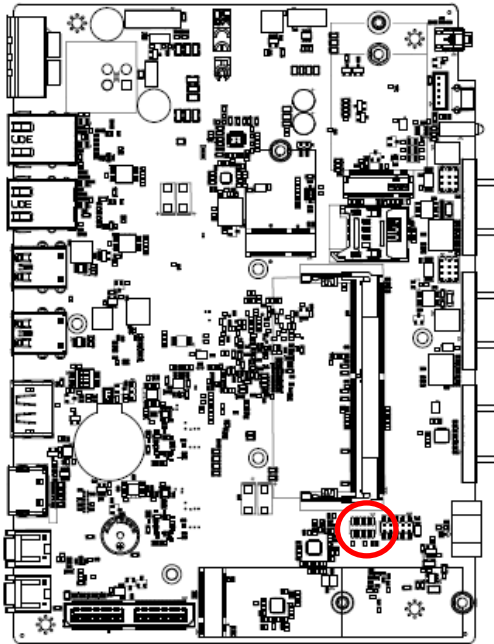

Signal	PIN	PIN	Signal
CN_ESPI_IO0	1	2	+3.3V
CN_ESPI_IO1	3	4	PLT_RST1#
CN_ESPI_IO2	5	6	ESPI_CS#0
CN_ESPI_IO3	7	8	CN_ESPI_CLK
NC	9	10	GND
ESPI_RST	11	12	ESPI_ALERT#2

2.4.6 BIOS SPI connector (BIOS_SPI)

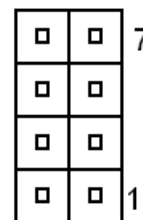
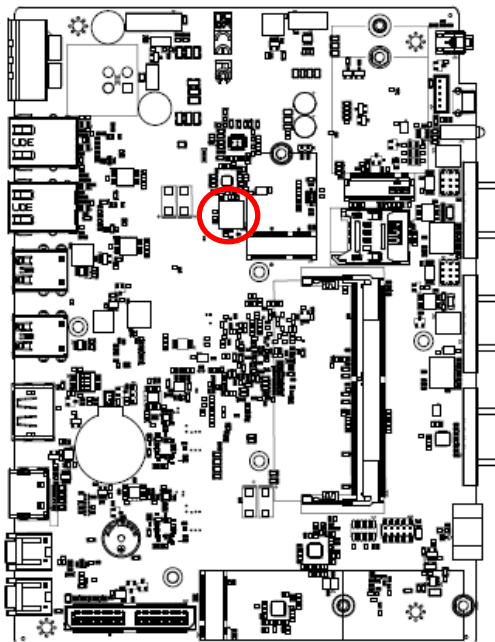

Signal	PIN	PIN	Signal
SPI_WP#	8	7	SPI_HOLD#
SPI_MOSI	6	5	SPI_MISO
SPI0_CLK	4	3	SPI_CS0#
GND	2	1	+3.3VSB

2.4.7 Front Panel connector (JFP1)

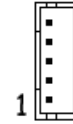
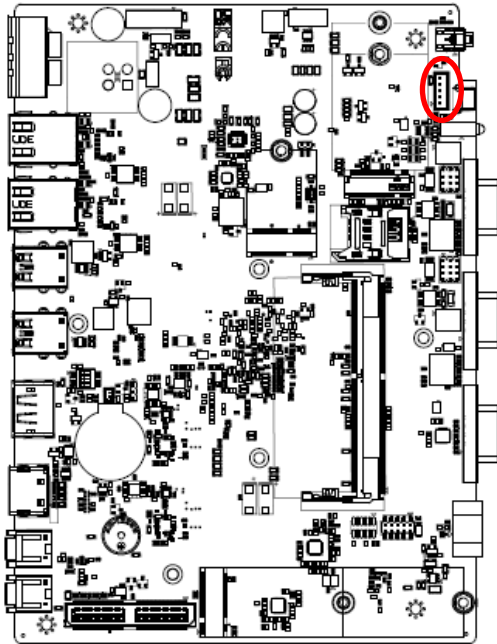

Signal	PIN
PWR_LED-	5
+5VSB	4
GND	3
PMC_RSTBTN#	2
PWR_BTN_IN_EC#	1

2.4.8 DC Output connector (DCOUT1)

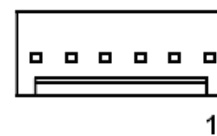
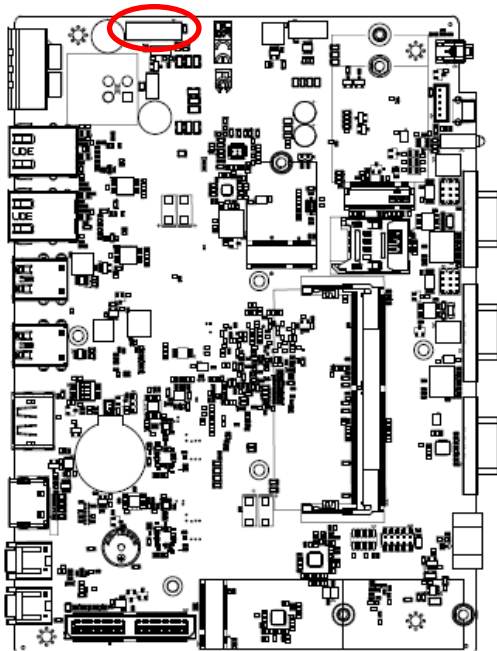

Signal	PIN
+V36_VIN	1
+V36_VIN	2
+V36_VIN	3
GND	4
GND	5
GND	6

2.4.9 DC Input connector (JVIN1)

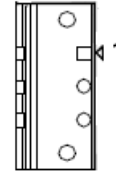
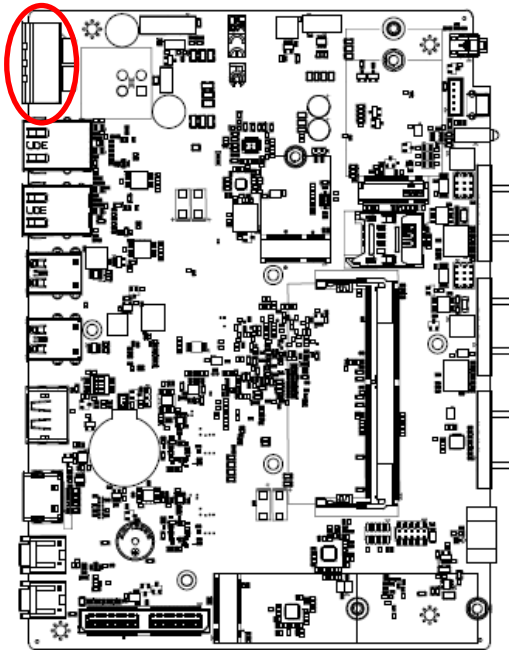

Signal	PIN
+DC_IN	1
CHASSIS_GND	2
GND	3

2.4.10 EC Debug connector (JEC_ROM1)

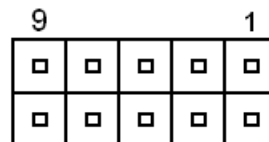
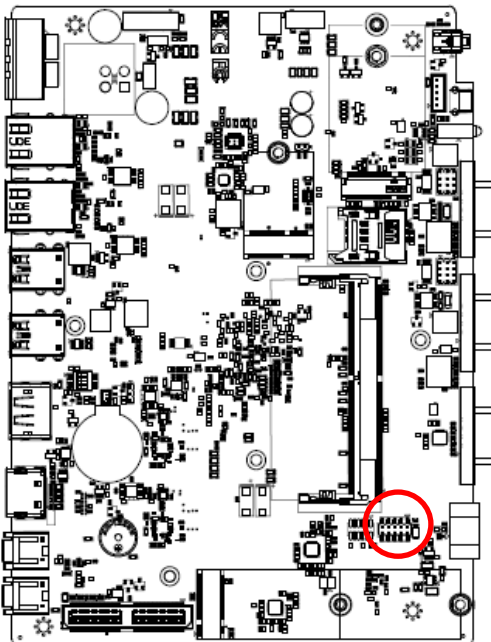

Signal	PIN	PIN	Signal
+VSPI_EC	1	2	GND
EC_FSCE#	3	4	EC_FSCK
EC_FMISO	5	6	EC_FMOSI
EC_HOLD#	7	8	NC
EC_SMCLK_DBG	9	10	EC_SMDAT_DBG

2.4.11 On-board header for USB2.0 (JUSB1)

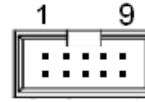
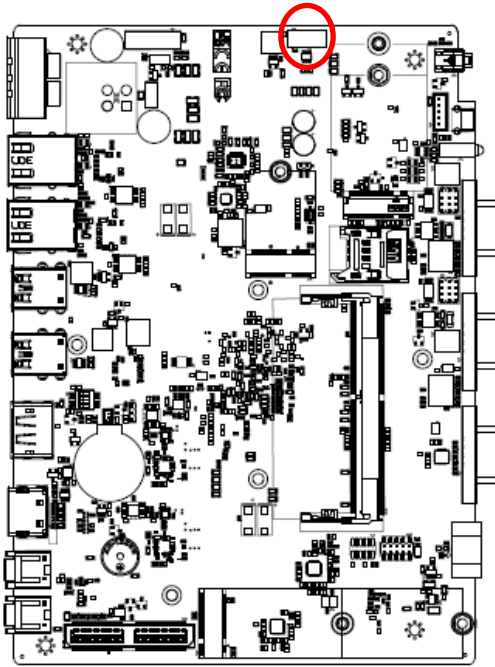

Signal	PIN	PIN	Signal
+5VSB	1	2	+5VSB
USB_R_DN3	3	4	USB_R_DN4
USB_R_DP3	5	6	USB_R_DP4
GND	7	8	GND
GND	9	10	GND

2.4.12 Power on/off connector (PWRBTN1)

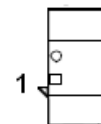
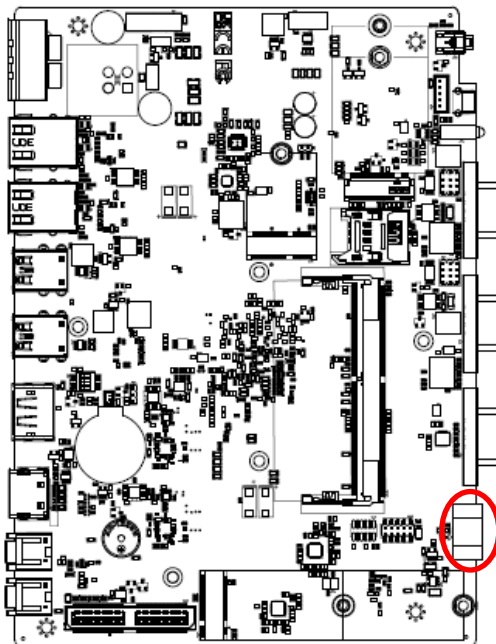

Signal	PIN
GND	2
PWRBTN#_R	1

2.4.13 IET connector (IET_CB1)

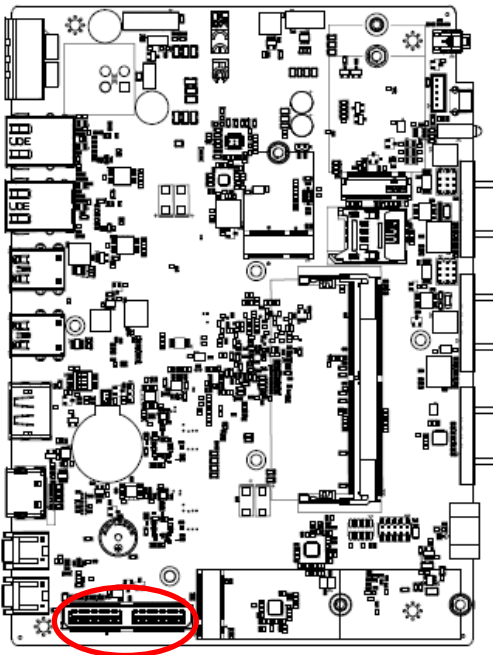

Signal	PIN	PIN	Signal
GND	1	2	GND
PCIE_SW1_RXP_1	3	4	PCIE_SW1_TXP_1
PCIE_SW1_RXN_1	5	6	PCIE_SW1_TXN_1
GND	7	8	GND
PCIE_SW1_RXP_2	9	10	PCIE_SW1_TXP_2
PCIE_SW1_RXN_2	11	12	PCIE_SW1_TXN_2
GND	13	14	GND
PCIE_SW2_RXP_1	15	16	PCIE_SW2_TXP_1
PCIE_SW2_RXN_1	17	18	PCIE_SW2_TXN_1
GND	19	20	GND

Signal	PIN	PIN	Signal
PCIE_SW2_RXP_2	21	22	PCIE_SW2_TXP_2
PCIE_SW2_RXN_2	23	24	PCIE_SW2_TXN_2
GND	25	26	GND
CLK_PCIE_P4	27	28	SIDEOUT_L
CLK_PCIE_N4	29	30	SIDEOUT_R
GND	31	32	GND
SMB_SCL_S5	33	34	NC
SMB_SDA_S5	35	36	DDIO_SEL
IET_WAKE#	37	38	IET_DB_TYPE0
PLT_RST_IET#	39	40	IET_DB_TYPE1
IET_PWRON	41	42	CLK_24M_BUF
NC	43	44	LPC_AD0
DDIO_HPDP	45	46	LPC_AD1
GND	47	48	LPC_AD2
DDIO_AUXP_CLK	49	50	LPC_AD3
DDIO_AUXP_DAT	51	52	LPC_LDRQ#
GND	53	54	LPC_SERIRQ
DDIO_C_TXP0	55	56	LPC_LFRAME#
DDIO_C_TXN0	57	58	GND
GND	59	60	USB_DP_7
DDIO_C_TXP1	61	62	USB_DN_7
DDIO_C_TXN1	63	64	GND
GND	65	66	USB_DP_8
DDIO_C_TXP2	67	68	USB_DN_8
DDIO_C_TXN2	69	70	GND
GND	71	72	USB_DP_9
DDIO_C_TXP3	73	74	USB_DN_9
DDIO_C_TXN3	75	76	GND
GND	77	78	USB2_OC3#
+12VSB	79	80	+12VSB

2.4.14 Battery connector (BATH2)

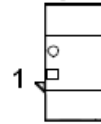
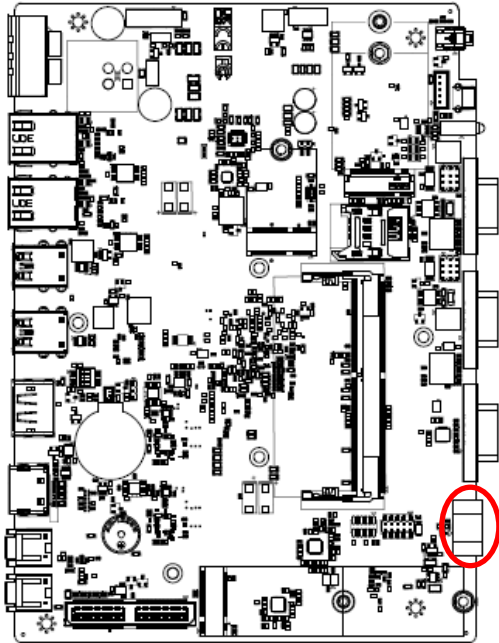

Signal	PIN
GND	2
PWRBTN#_R	1

2.5 Installing Hard Disk & Memory (EMS-EHL)

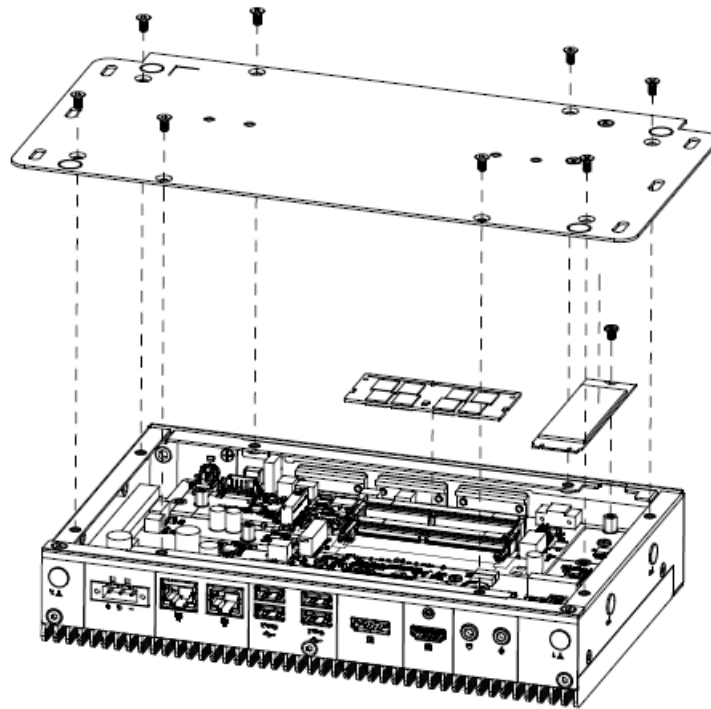

Step 1. Remove 8 screws from the bottom of your system and take it off.

Step 2. Slide the DDR4 SODIMM into the memory socket and press it down until properly seated.

Step 3. Insert M.2 Key-B card into designated locations, between M.2 and thermal solution please paste with thermal pad, and fasten with screws to complete installation.

3. BIOS Setup

3.1 Introduction

The BIOS setup program allows users to modify the basic system configuration. In this following chapter will describe how to access the BIOS setup program and the configuration options that may be changed.

3.2 Starting Setup

The AMI BIOS™ is immediately activated when you first power on the computer. The BIOS reads the system information contained in the NVRAM and begins the process of checking out the system and configuring it. When it finishes, the BIOS will seek an operating system on one of the disks and then launch and turn control over to the operating system.

While the BIOS is in control, the Setup program can be activated in one of two ways:

By pressing or <F2> immediately after switching the system on, or

By pressing the or <F2> key when the following message appears briefly at the left-top of the screen during the POST (Power On Self Test).

Press or <F2> to enter SETUP

If the message disappears before you respond and you still wish to enter Setup, restart the system to try again by turning it OFF then ON or pressing the "RESET" button on the system case. You may also restart by simultaneously pressing <Ctrl>, <Alt>, and <Delete> keys. If you do not press the keys at the correct time and the system does not boot, an error message will be displayed and you will again be asked to.

Press F1 to Continue, DEL to enter SETUP

3.3 Using Setup

In general, you use the arrow keys to highlight items, press <Enter> to select, use the PageUp and PageDown keys to change entries, press <F1> for help and press <Esc> to quit. The following table provides more detail about how to navigate in the Setup program using the keyboard.

Button	Description
↑	Move to previous item
↓	Move to next item
←	Move to the item in the left hand
→	Move to the item in the right hand
Esc key	Main Menu -- Quit and not save changes into NVRAM Status Page Setup Menu and Option Page Setup Menu -- Exit current page and return to Main Menu
+ key	Increase the numeric value or make changes
- key	Decrease the numeric value or make changes
F1 key	General help, only for Status Page Setup Menu and Option Page Setup Menu
F2 key	Previous Values.
F3 key	Optimized defaults
F4 key	Save & Exit Setup

- **Navigating Through The Menu Bar**

Use the left and right arrow keys to choose the menu you want to be in.



Note: Some of the navigation keys differ from one screen to another.

- **To Display a Sub Menu**

Use the arrow keys to move the cursor to the sub menu you want. Then press <Enter>. A “>” pointer marks all sub menus.

3.4 Getting Help

Press F1 to pop up a small help window that describes the appropriate keys to use and the possible selections for the highlighted item. To exit the Help Window press <Esc> or the F1 key again.

3.5 In Case of Problems

If, after making and saving system changes with Setup, you discover that your computer no longer is able to boot, the AMI BIOS supports an override to the NVRAM settings which resets your system to its defaults.

The best advice is to only alter settings which you thoroughly understand. To this end, we strongly recommend that you avoid making any changes to the chipset defaults. These defaults have been carefully chosen by both BIOS Vendor and your systems manufacturer to provide the absolute maximum performance and reliability. Even a seemingly small change to the chipset setup has the potential for causing you to use the override.

3.6 BIOS setup

Once you enter the Aptio Setup Utility, the Main Menu will appear on the screen. The Main Menu allows you to select from several setup functions and exit choices. Use the arrow keys to select among the items and press <Enter> to accept and enter the sub-menu.

3.6.1 Main Menu

This section allows you to record some basic hardware configurations in your computer and set the system clock.

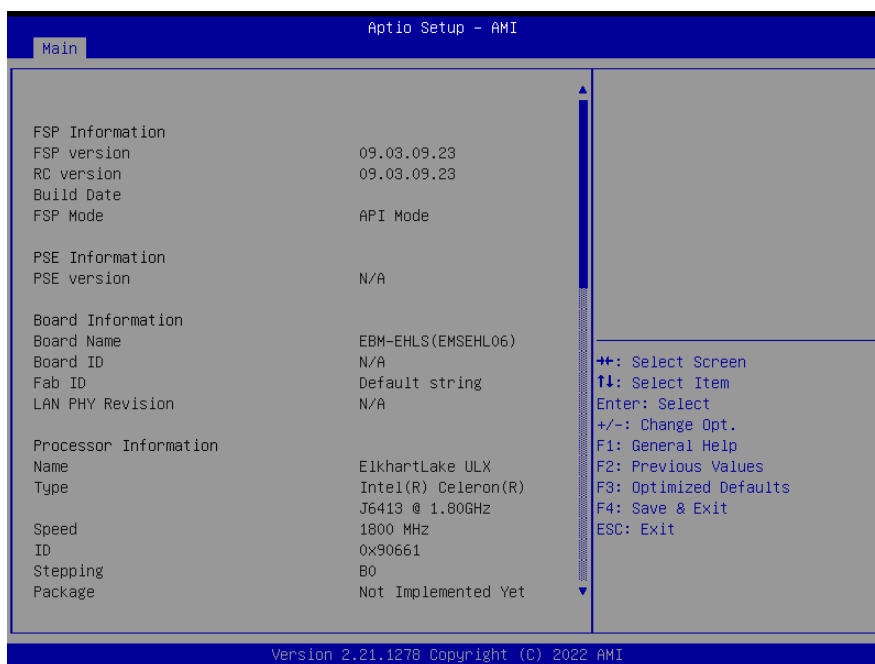
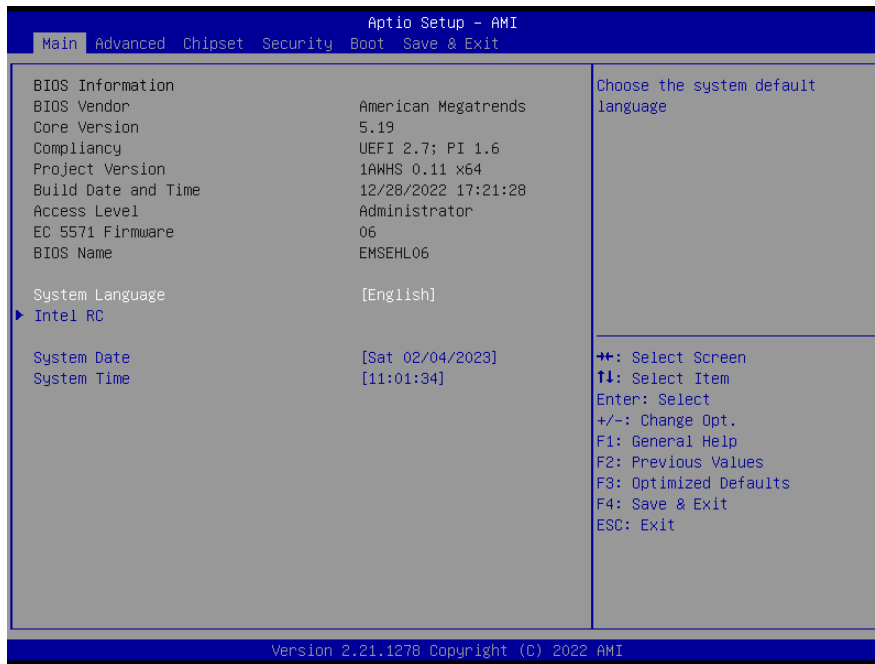

3.6.1.1 System Language

This option allows choosing the system default language.

3.6.1.2 System Date

Use the system date option to set the system date. Manually enter the day, month and year.

3.6.1.3 System Time

Use the system time option to set the system time. Manually enter the hours, minutes and seconds.



Note: The BIOS setup screens shown in this chapter are for reference purposes only, and may not exactly match what you see on your screen. Visit the Avalue website (www.avalue.com.tw) to download the latest product and BIOS information.

3.6.2 Advanced Menu

This section allows you to configure your CPU and other system devices for basic operation through the following sub-menus.



EMS-EHL

3.6.2.1 CPU Configuration

Use the CPU configuration menu to view detailed CPU specification and configure the CPU.

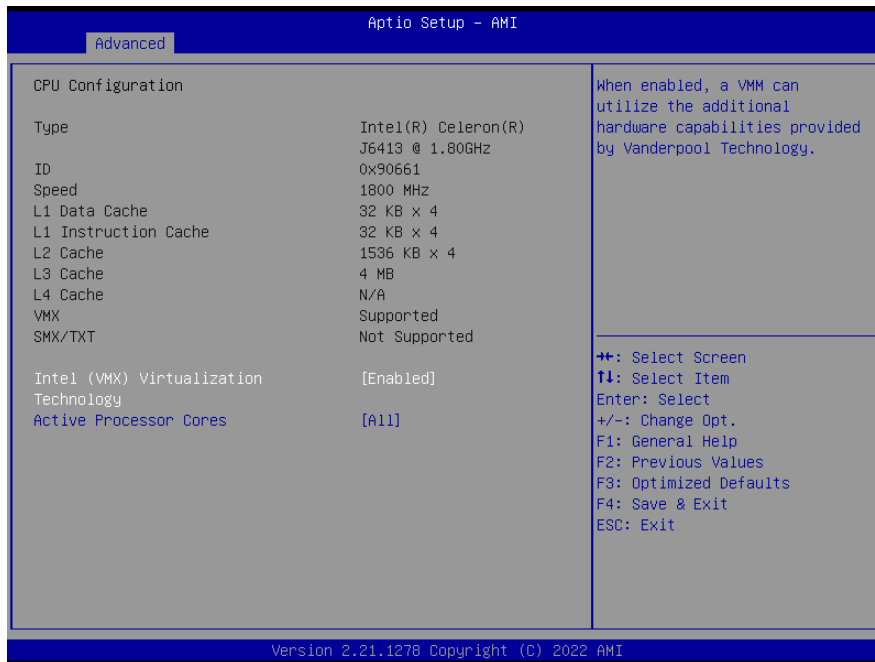

Item	Options	Description
Intel(VMX) Virtualization Technology	Disabled Enabled[Default]	When enabled, a VMM can utilize the additional hardware capabilities provided by Vanderpool Technology.
Active Processor Cores	All[Default] 1 2 3	Number of cores to enable in each processor package.

3.6.2.2 Power & Performance

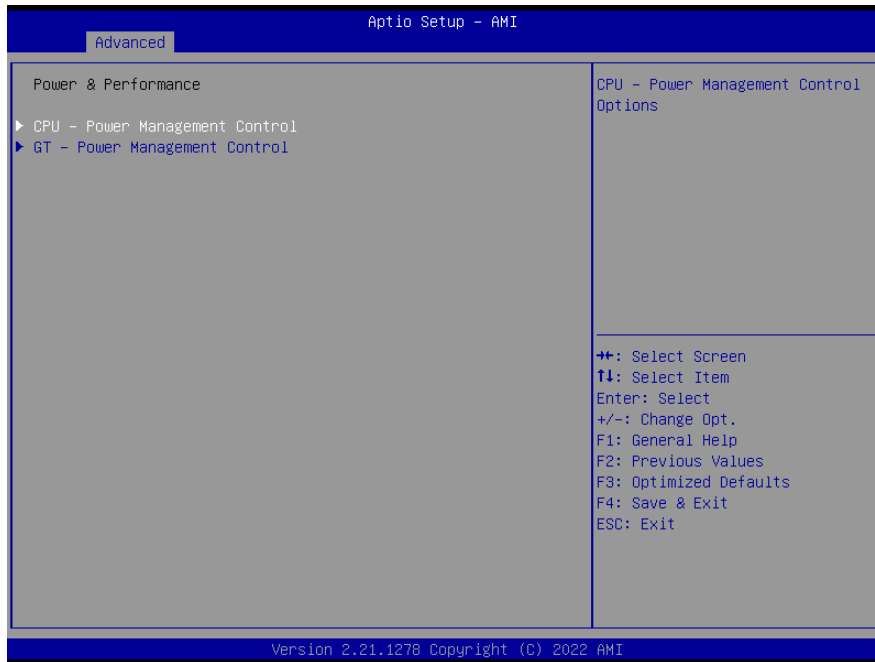

3.6.2.2.1 CPU - Power Management Control



Item	Option	Description
Boot performance mode	Max Non Turbo Performance[Default], Turbo Performance	Select the performance state that the BIOS will set starting from reset vector.
Intel® SpeedSted™	Disabled Enabled[Default],	Allows more than two frequency ranges to be supported.
Intel® Speed Shift Technology	Disabled[Default], Enabled	Enable/Disable Intel® Speed Shift Technology support. Enabling will expose the CPPC v2 interface to allow for hardware controlled

EMS-EHL

		P-states.
Turbo Mode	Disabled Enabled[Default],	Enable/Disable processor Turbo Mode (requires EMTTM enabled too). AUTO means enabled.
C states	Disabled[Default], Enabled	Enable/Disable CPU Power Management. Allows CPU to go to C states when it's not 100% utilized.

3.6.2.2.1 View/Configure Turbo Options

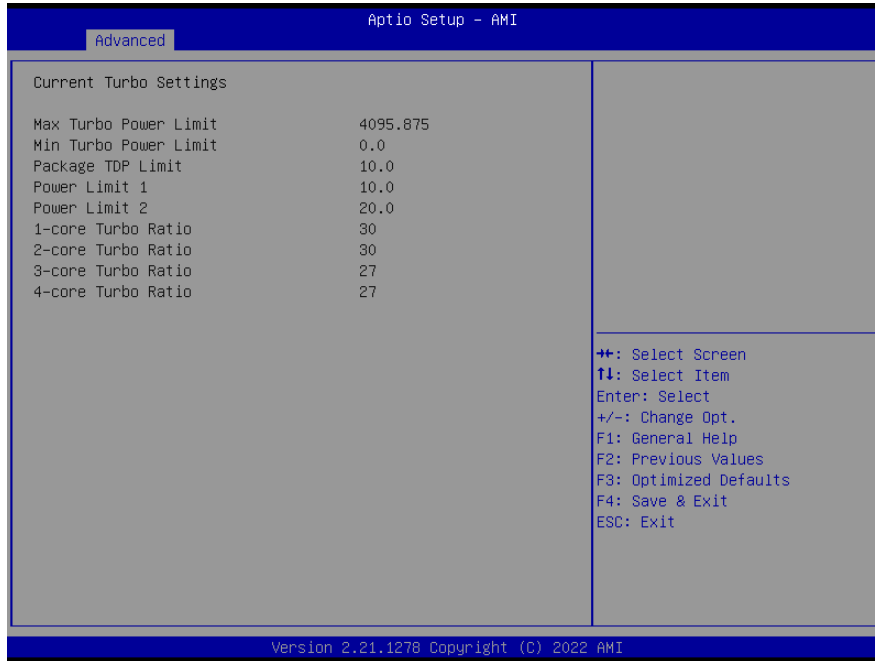

3.6.2.2.2 GT - Power Management Control



Item	Option	Description
RC6(Render Standby)	Disabled	Check to enable render standby support.

	Enabled[Default],	
Disable Turbo GT frequency	Disabled[Default], Enabled	Enabled: Disables Turbo GT frequency. Disabled: GT frequency is not limited

3.6.2.3 PCH-FW Configuration

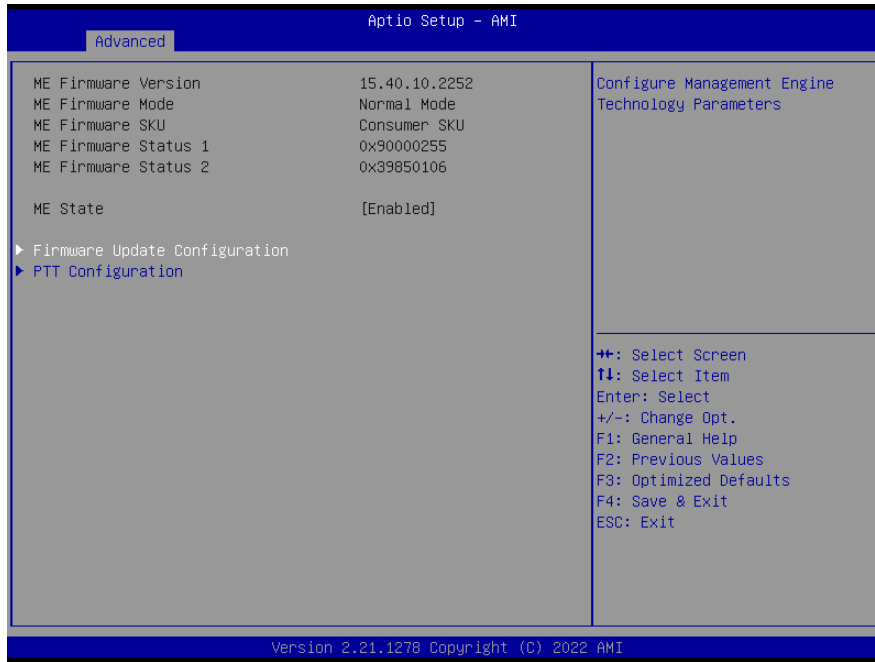

3.6.2.3.1 Firmware Update Configuration

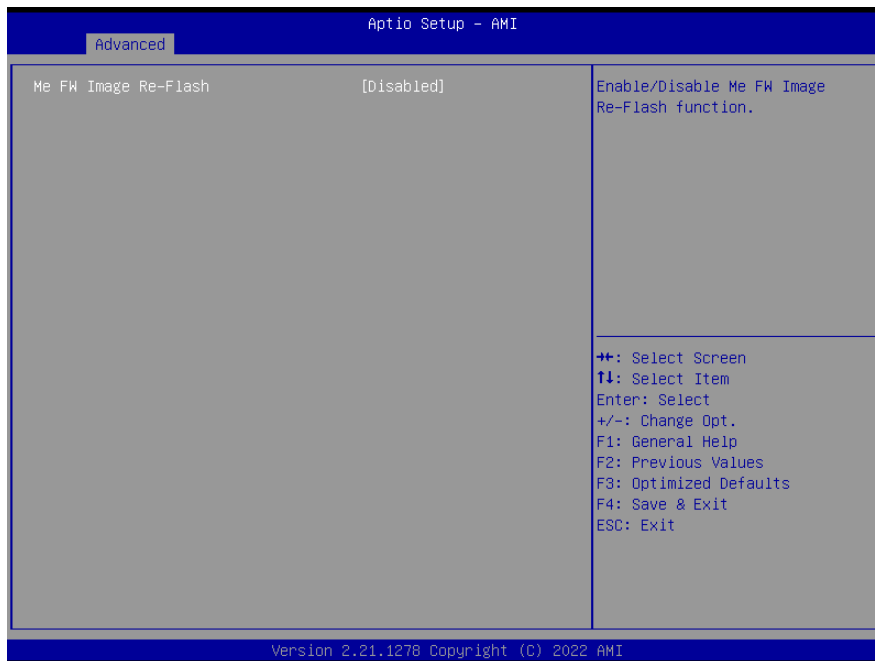

Item	Option	Description
Me FW Image Re-Flash	Disabled[Default], Enabled	Enable/Disable Me FW Image Re-Flash function.

3.6.2.3.2 PTT Configuration

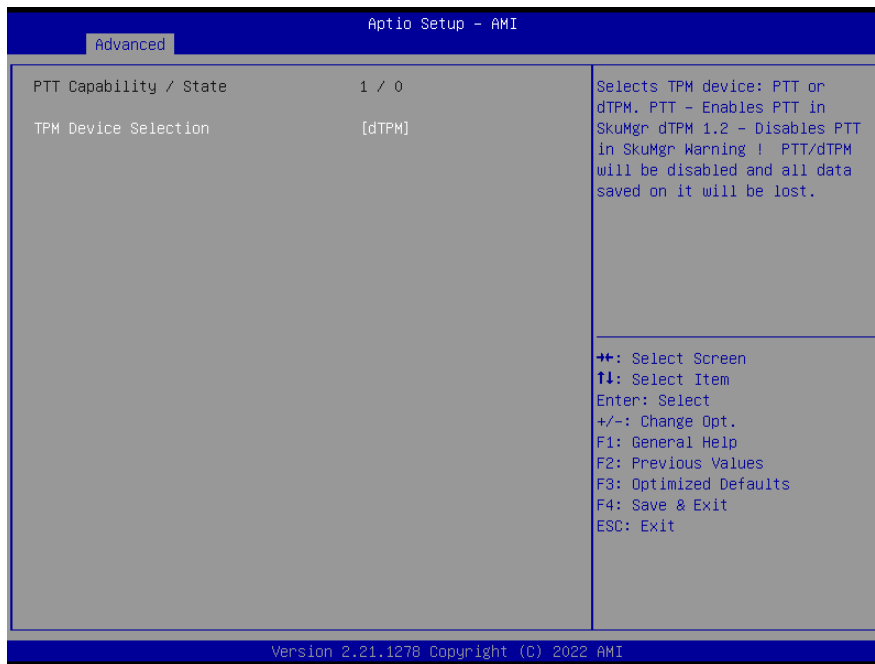

Item	Option	Description
TPM Device Selection	dTPM[Default], PTT	Selects TPM device: PTT or dTPM. PTT - Enables PTT in SkuMgr dTPM 1.2 - Disables PTT in SkuMgr Warning ! PTT/dTPM will be disabled and all data saved on it will be lost.

3.6.2.4 Trusted Computing



Item	Options	Description
Security Device Support	Disable Enable[Default]	Enables or Disables BIOS support for security device. O.S. will not show Security Device. TCG EFI protocol and INT1A interface will not be available.

3.6.2.5 ACPI Settings

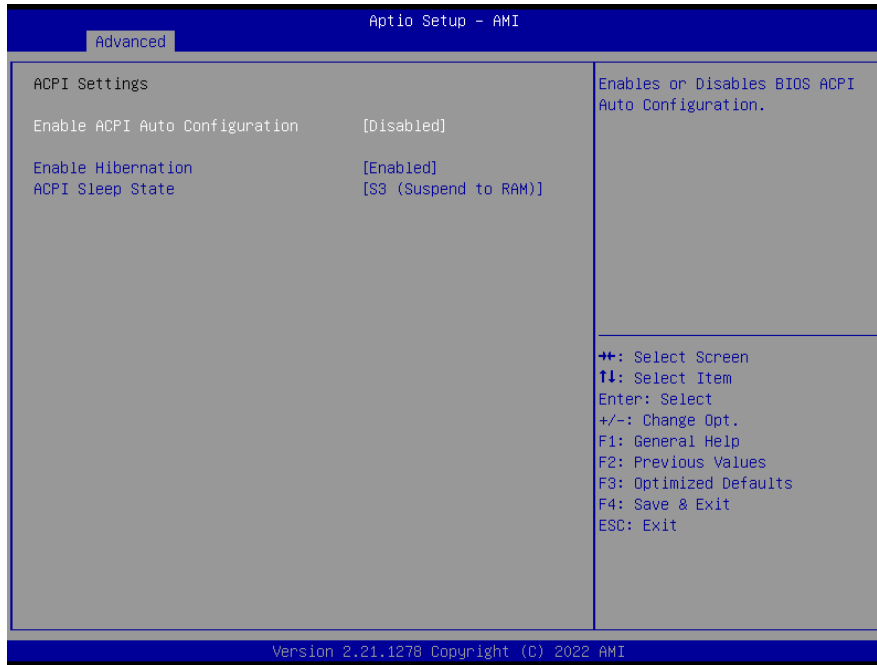

Item	Options	Description
Enable ACPI Auto Configuration	Disabled[Default], Enabled	Enables or Disables BIOS ACPI Auto Configuration.
Enable Hibernation	Disabled Enabled[Default],	Enables or Disables System ability to Hibernate (OS/S4 Sleep State). This option may be not effective with some Operating Systems.
ACPI Sleep State	Suspend Disabled, S3 (Suspend to RAM) [Default]	Select the highest ACPI sleep state the system will enter when the SUSPEND button is pressed.

3.6.2.6 IT5571 Super IO Configuration

You can use this item to set up or change the IT8528 Super IO configuration for serial ports. Please refer to 3.6.2.6.1~ 3.6.2.6.6 for more information.

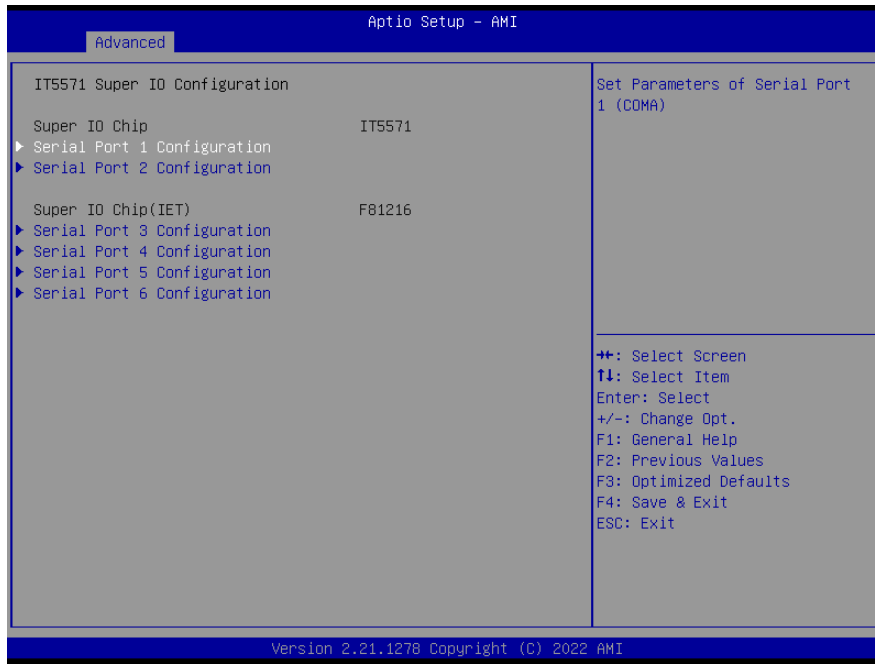

Item	Description
Serial Port 1 Configuration	Set Parameters of Serial Port 1 (COMA).
Serial Port 2 Configuration	Set Parameters of Serial Port 2 (COMB).
Serial Port 3 Configuration	Set Parameters of Serial Port 3 (COMC).
Serial Port 4 Configuration	Set Parameters of Serial Port 4 (COMD).
Serial Port 5 Configuration	Set Parameters of Serial Port 5 (COME).
Serial Port 6 Configuration	Set Parameters of Serial Port 5 (COMF).

3.6.2.6.1 Serial Port 1 Configuration

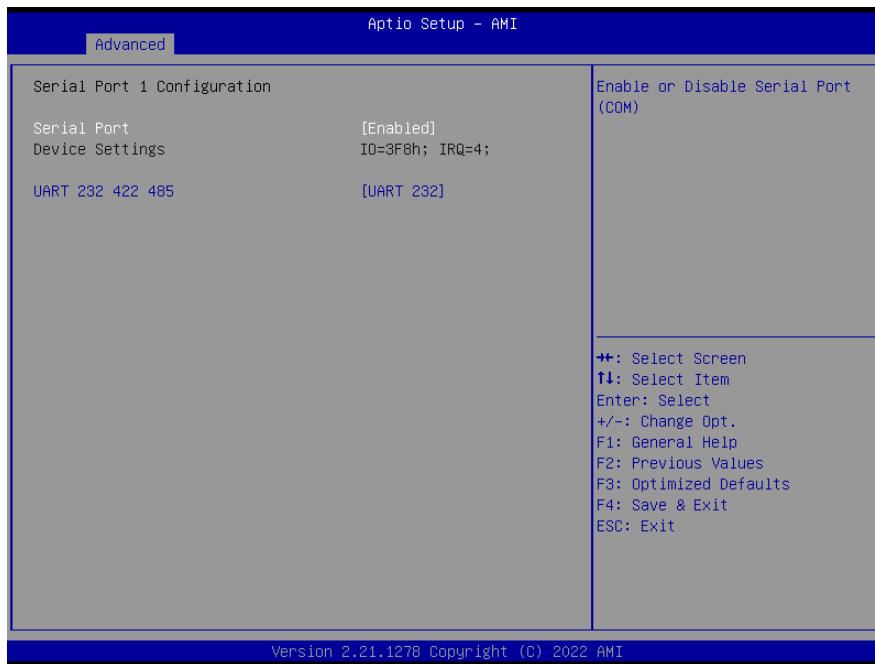

Item	Option	Description
Serial Port	Disabled Enabled[Default],	Enable or Disable Serial Port (COM).
UART 232 422 485	UART 232[Default] UART 422 UART 485	Change the Serial Port as RS232/422/485.

3.6.2.6.2 Serial Port 2 Configuration

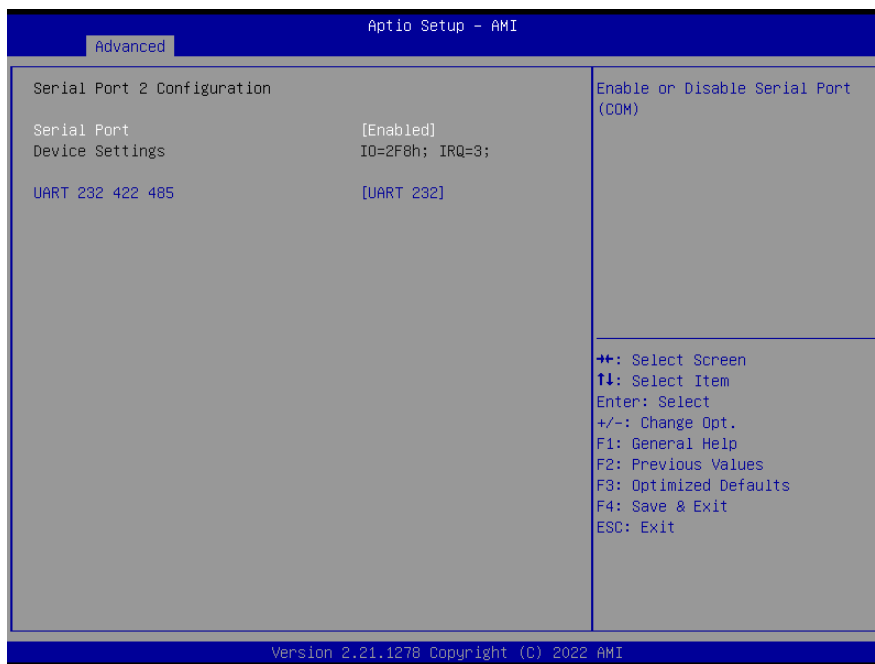

EMS-EHL

Item	Option	Description
Serial Port	Disabled Enabled[Default],	Enable or Disable Serial Port (COM).
UART 232 422 485	UART 232[Default] UART 422 UART 485	Change the Serial Port as RS232/422/485.

3.6.2.6.3 Serial Port 3 Configuration

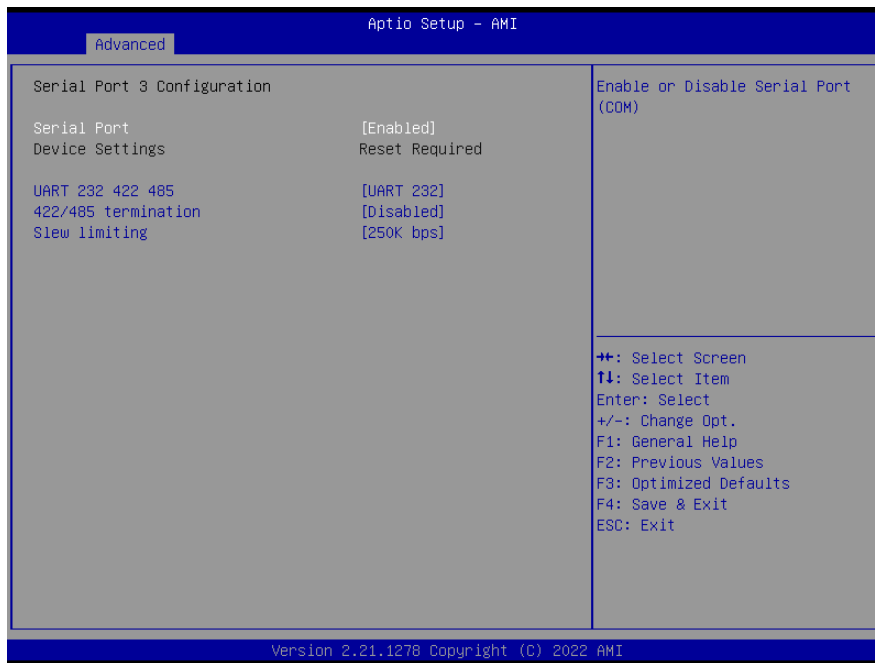

Item	Option	Description
Serial Port	Disabled Enabled[Default],	Enable or Disable Serial Port (COM).
UART 232 422 485	UART 232(LOOPBACK) UART 232[Default] UART 422 UART 485	Change the Serial Port as RS232/422/485.
422/485 termination	Disabled[Default], Enabled	Adjust the Serial Port with internal or external termination resistors
Slew limiting	10M bps 250k bps[Default]	SLEW from GPIO.

3.6.2.6.4 Serial Port 4 Configuration

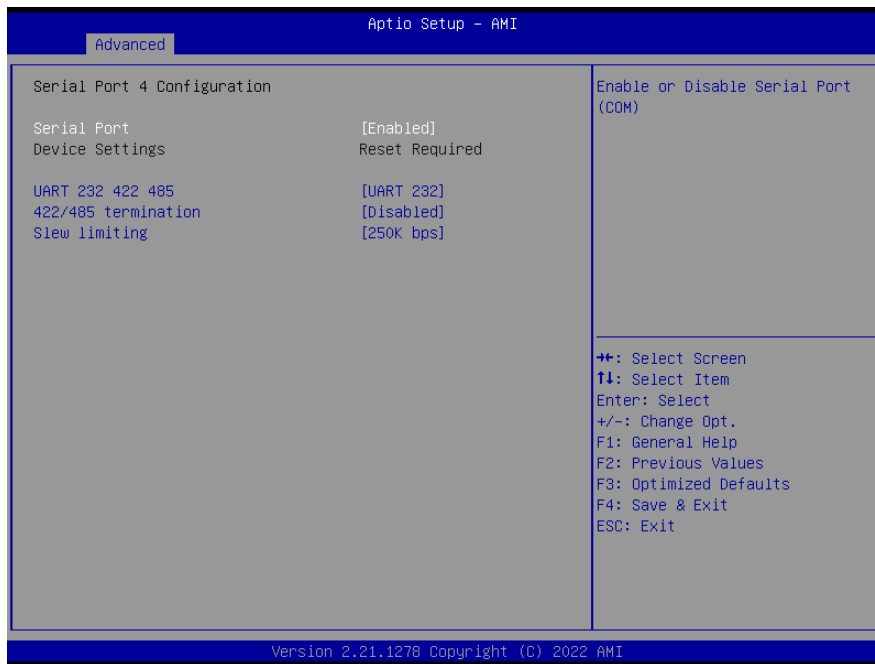

Item	Option	Description
Serial Port	Disabled Enabled[Default],	Enable or Disable Serial Port (COM).
UART 232 422 485	UART 232(LOOPBACK) UART 232[Default] UART 422 UART 485	Change the Serial Port as RS232/422/485.
422/485 termination	Disabled[Default], Enabled	Adjust the Serial Port with internal or external termination resistors
Slew limiting	10M bps 250k bps[Default]	SLEW from GPIO.

3.6.2.6.5 Serial Port 5 Configuration

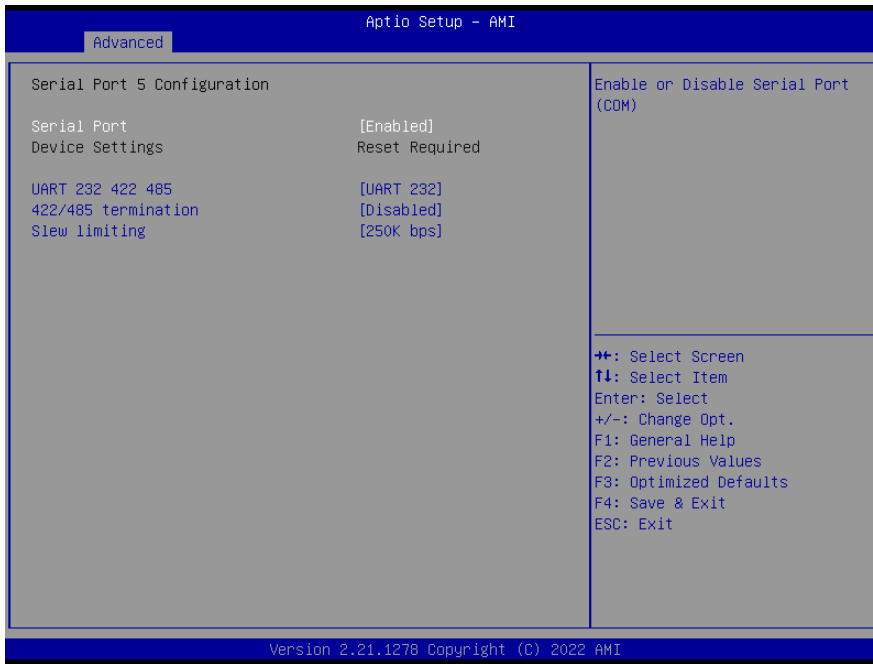

Item	Option	Description
Serial Port	Disabled Enabled[Default],	Enable or Disable Serial Port (COM).
UART 232 422 485	UART 232(LOOPBACK) UART 232[Default] UART 422 UART 485	Change the Serial Port as RS232/422/485.
422/485 termination	Disabled[Default], Enabled	Adjust the Serial Port with internal or external termination resistors
Slew limiting	10M bps 250k bps[Default]	SLEW from GPIO.

3.6.2.6.6 Serial Port 6 Configuration

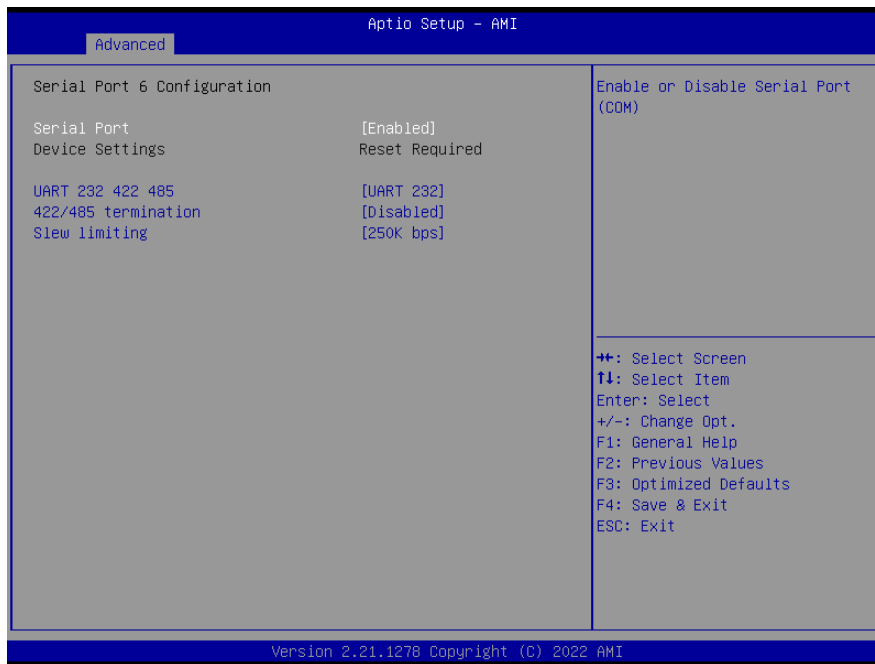

Item	Option	Description
Serial Port	Disabled Enabled[Default],	Enable or Disable Serial Port (COM).
UART 232 422 485	UART 232(LOOPBACK) UART 232[Default] UART 422 UART 485	Change the Serial Port as RS232/422/485.
422/485 termination	Disabled[Default], Enabled	Adjust the Serial Port with internal or external termination resistors
Slew limiting	10M bps 250k bps[Default]	SLEW from GPIO.

3.6.2.7 H/W Monitor

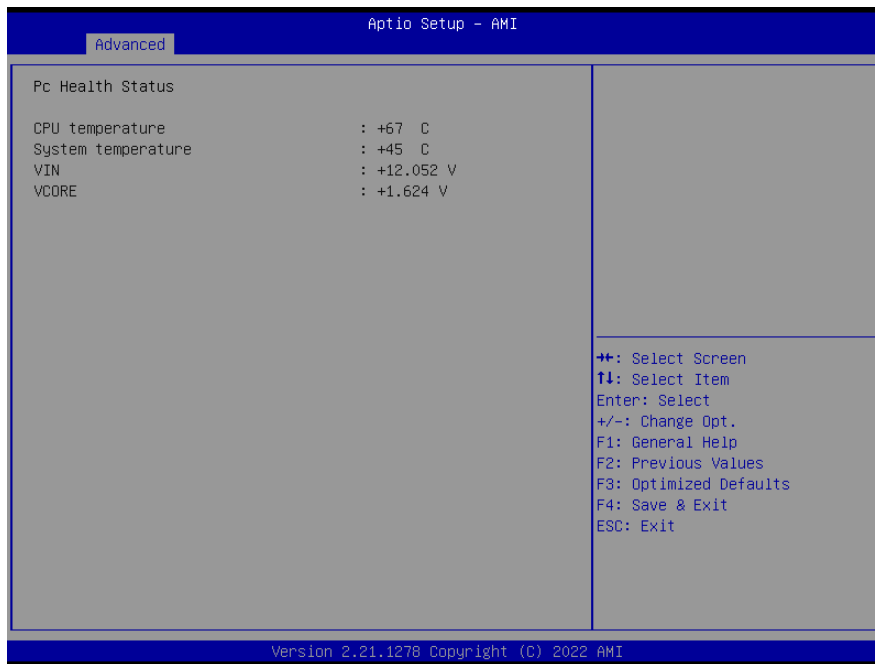

3.6.2.8 S5 RTC Wake Settings



Item	Options	Description
Wake system from S5	Disabled[Default], Fixed Time Dynamic Time	Enable or disable System wake on alarm event. Select Fixed Time, system will wake on the hr::min::sec specified. Select Dynamic Time, System will wake on the current time + Increase minute(s).

3.6.2.9 Serial Port Console Redirection

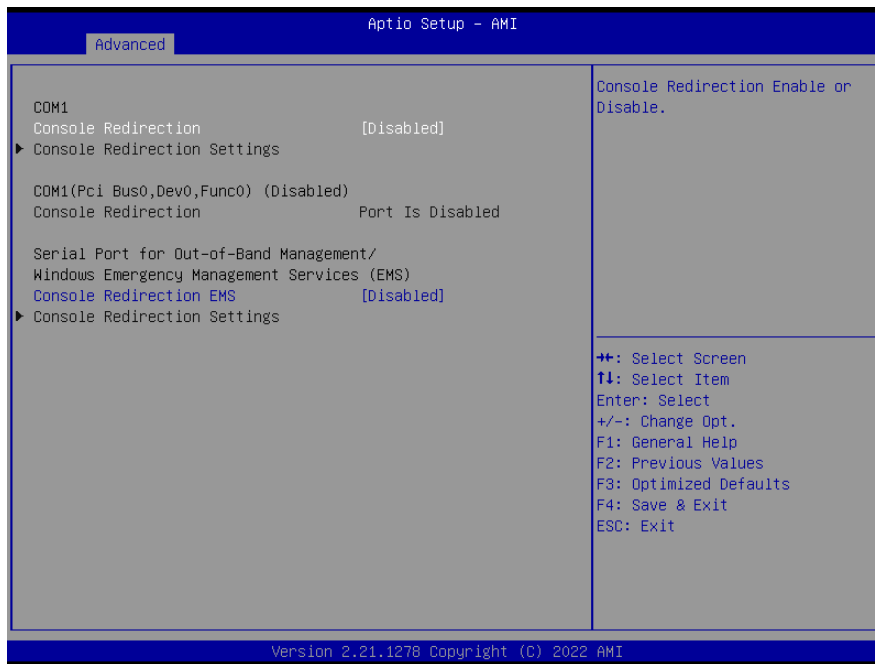

Item	Options	Description
Console Redirection	Disabled[Default], Enabled	Console Redirection Enable or Disable.
Console Redirection EMS	Disabled[Default], Enabled	Console Redirection Enable or Disable.

3.6.2.10 USB Configuration

The USB Configuration menu helps read USB information and configures USB settings.

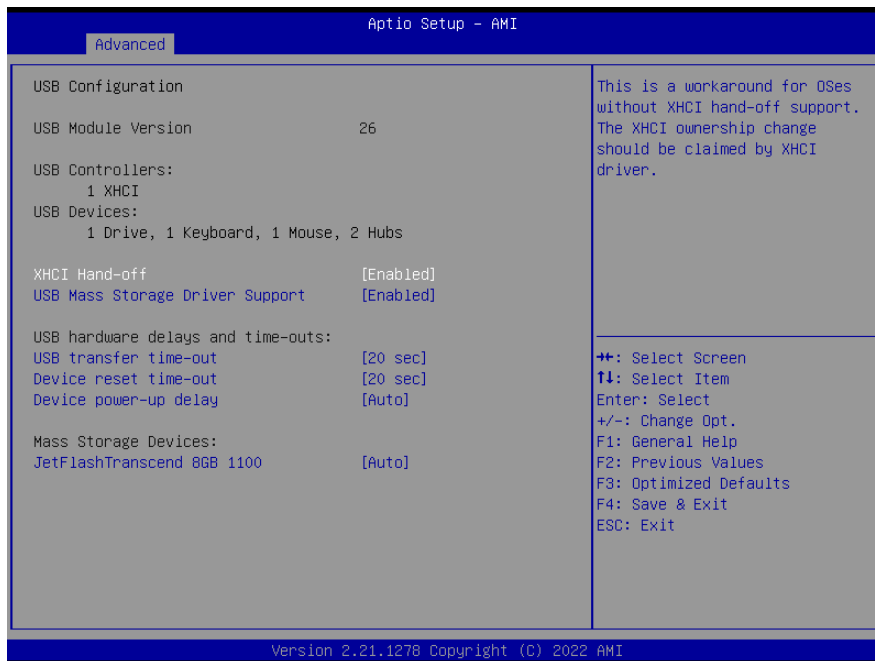

EMS-EHL

Item	Options	Description
XHCI Hand-off	Enabled[Default], Disabled	This is a workaround for OSES without XHCI hand-off support. The XHCI ownership change should be claimed by XHCI driver.
USB Mass Storage Driver Support	Disabled Enabled[Default],	Enable/Disable USB Mass Storage Driver Support.
USB transfer time-out	1 sec 5 sec 10 sec 20 sec[Default]	The time-out value for Control, Bulk, and Interrupt transfers.
Device reset time-out	10 sec 20 sec[Default] 30 sec 40 sec	USB mass storage device Start Unit command time-out.
Device power-up delay	Auto[Default] Manual	Maximum time the device will take before it properly reports itself to the Host Controller. 'Auto' uses default value: for a Root port it is 100ms, for a Hub port the delay is taken form Hub descriptor.
JetFlashTranscend 8GB 1100	Auto[Default] Floppy Forced FDD Hard Disk CD-ROM	Mass storage device emulation type. 'AUTO' enumerates devices according to their media format. Optical drives are emulated as 'CDROM', drives with no media will be emulated according to a drive type.

3.6.2.11 Network Stack Configuration

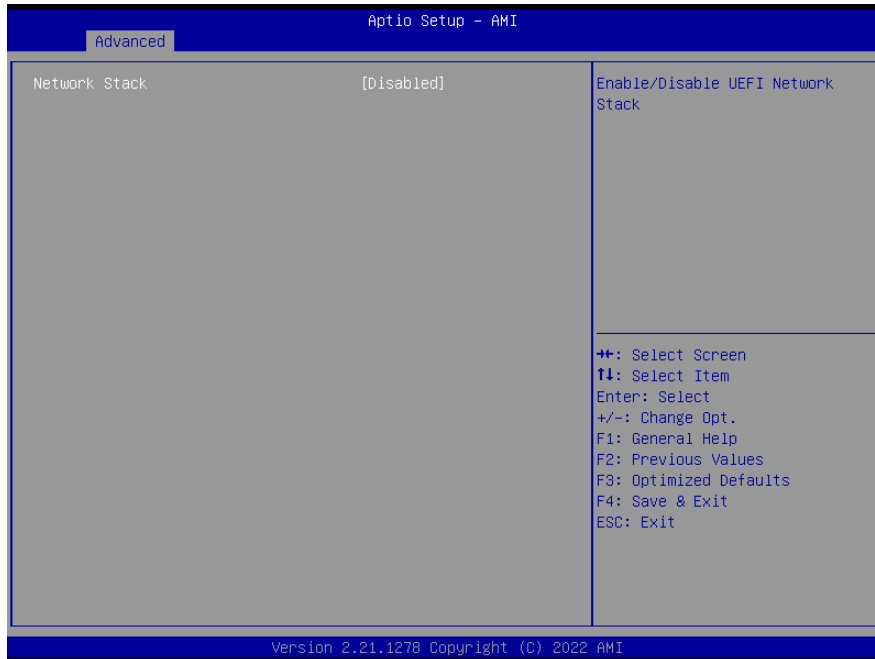

Item	Options	Description
Network Stack	Disabled[Default], Enabled	Enable/Disable UEFI Network Stack.

3.6.2.12 NVMe Configuration

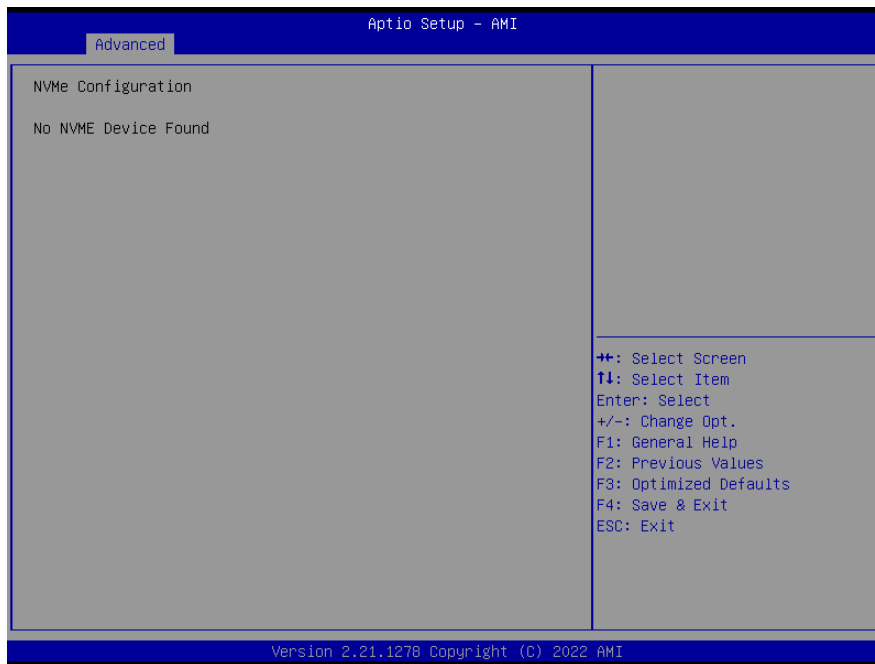

3.6.2.13 Intel® Ethernet Controller I226-IT – 00:04:5F:96:CF:22

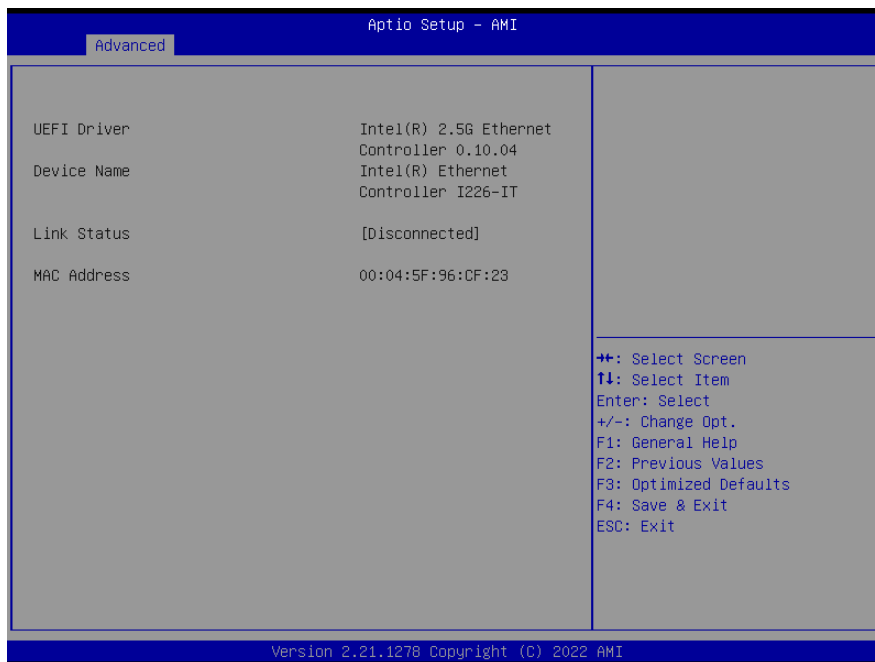

3.6.2.14 Intel® Ethernet Controller I226-IT – 00:04:5F:96:CF:23

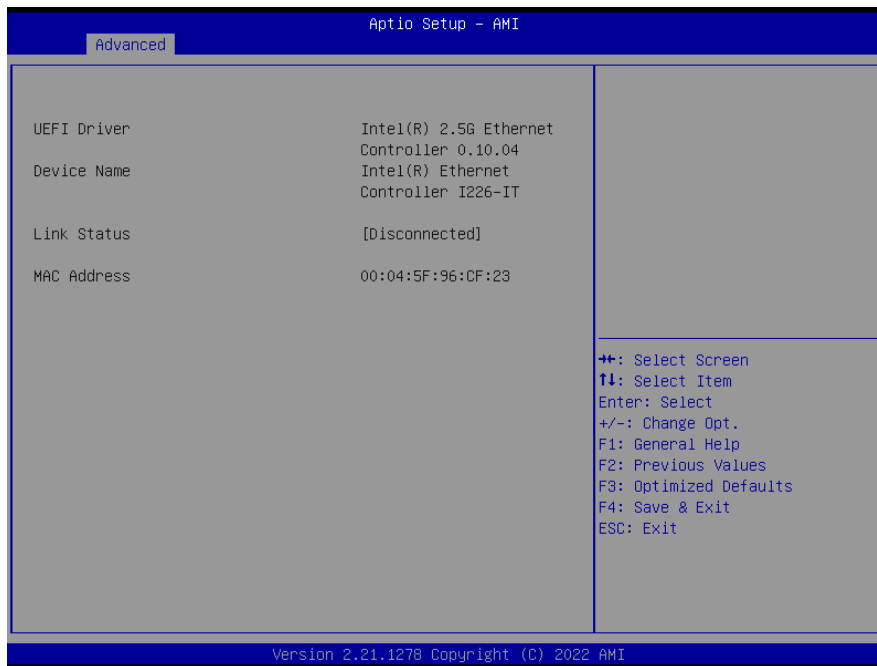

3.6.2.15 Driver Health

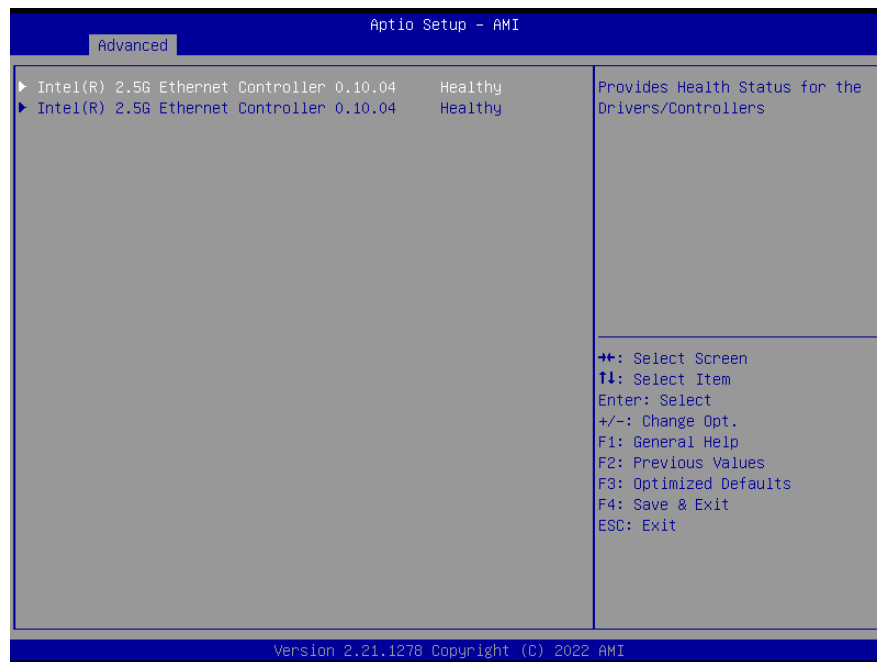

3.6.3 Chipset

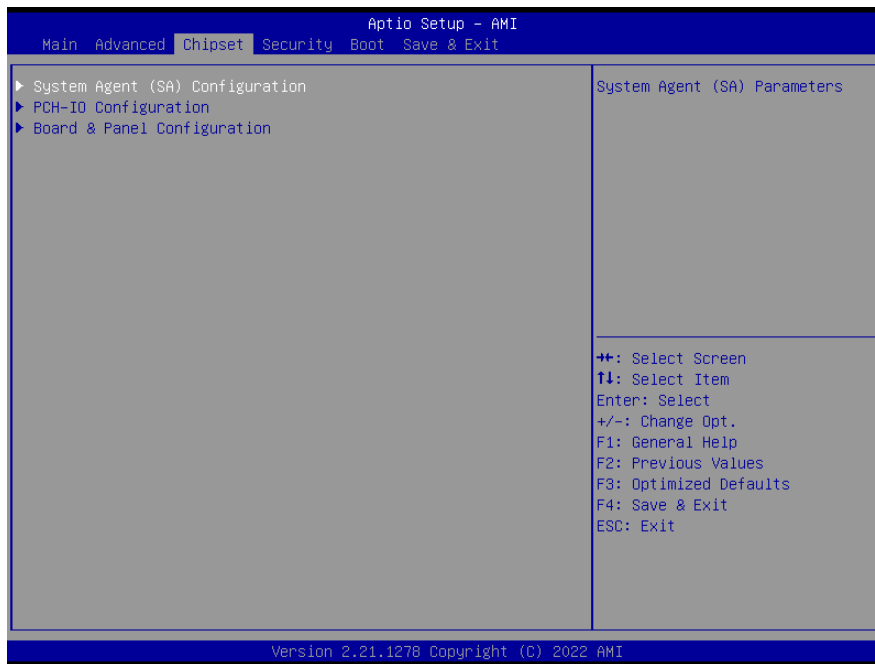

3.6.3.1 System Agent (SA) Configuration

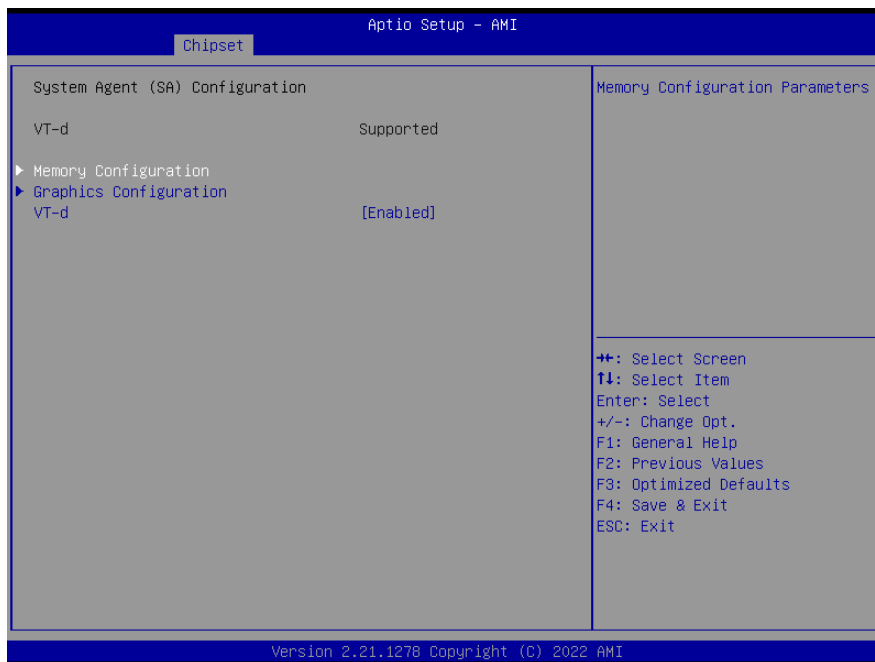

Item	Option	Description
VT-d	Disabled Enabled[Default]	VT-d capability.

3.6.3.1.1 Memory Configuration

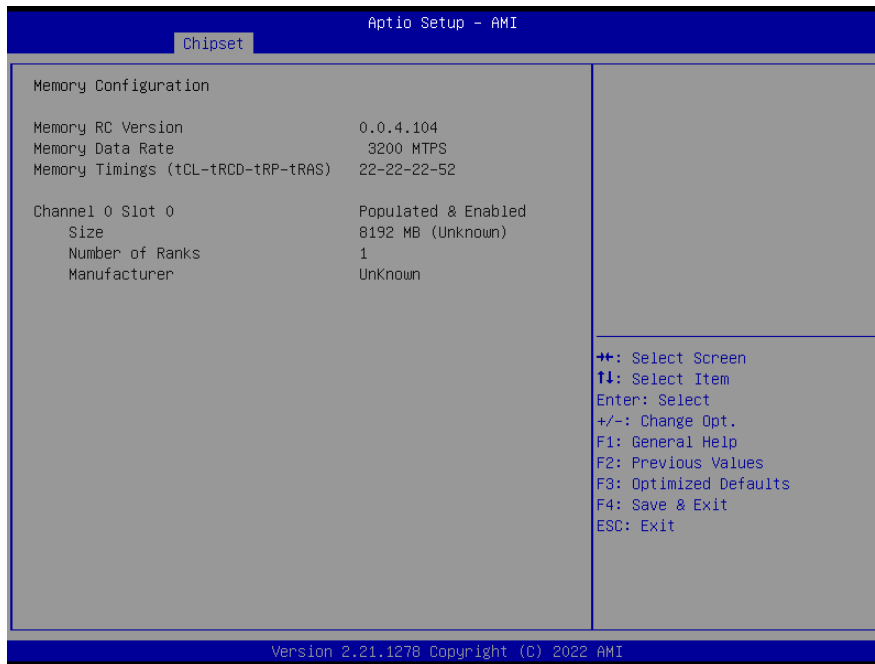

3.6.3.1.2 Graphics Configuration

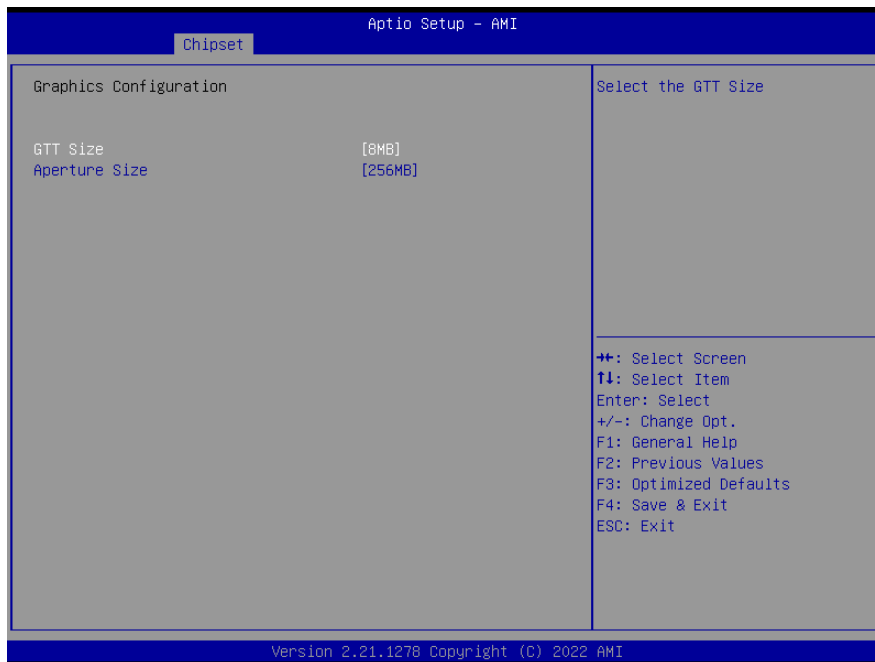

Item	Option	Description
GTT Size	2MB	Select GTT Size
	4MB	
	8MB[Default]	
Aperture Size	128MB	Select the Aperture Size Note : Above 4GB MMIO BIOS assignment is automatically enabled when selecting 2048MB aperture. To use this feature, please disable CSM Support.
	256MB[Default]	
	512MB	
	1024MB	

3.6.3.2 PCH-IO Configuration



3.6.3.2.1 PCI Express Configuration

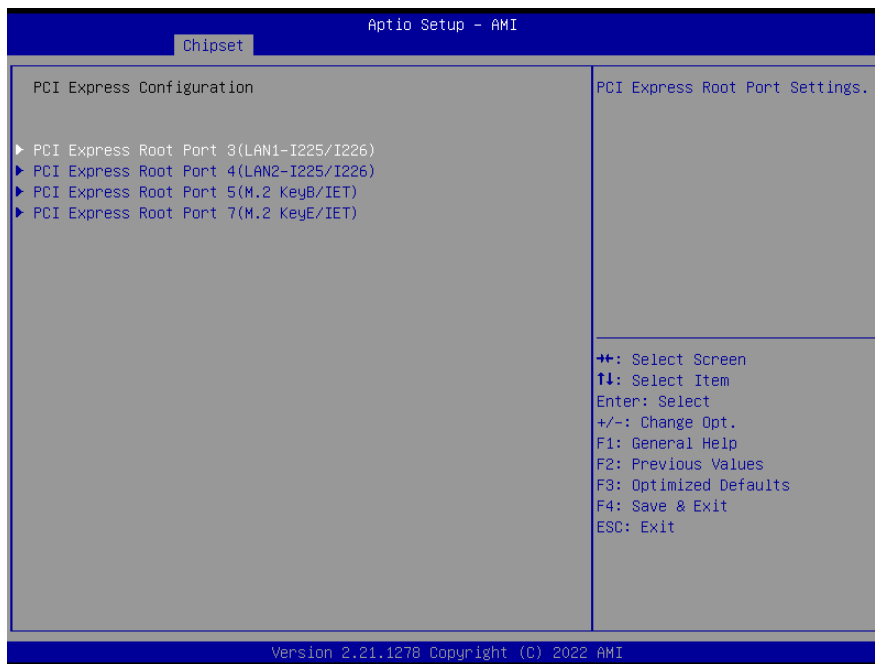

3.6.3.2.1.1 PCI Express Root Port 3(LAN1-I225/I226)

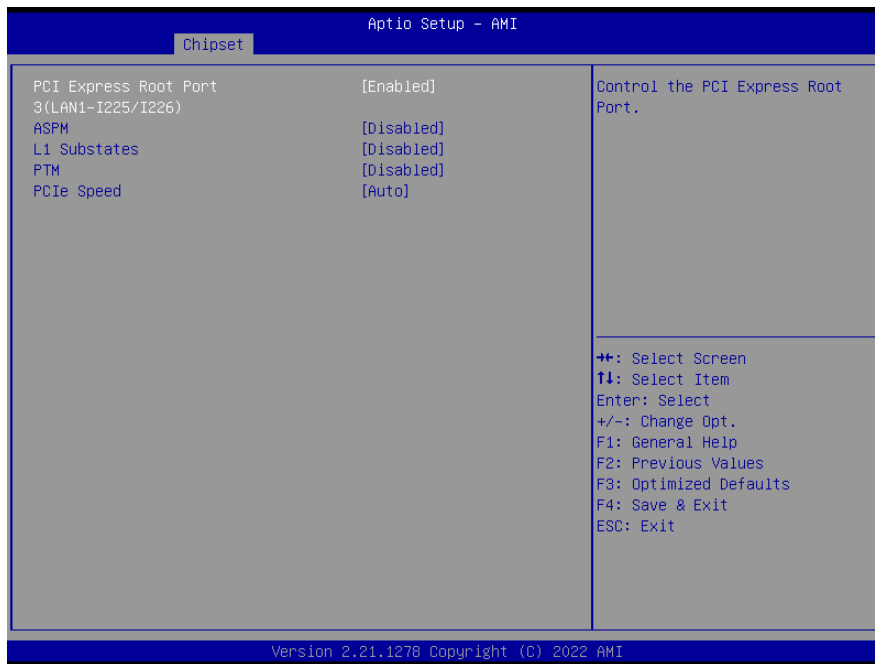

Item	Option	Description
PCI Express Root Port 3 (LAN1-I225/I226)	Disabled Enabled [Default] ,	Control the PCI Express Root Port.
ASPM	Disabled [Default] L0s L1 L0sL1 Auto	Set the ASPM Level: Force L0s – Force all links to L0s State AUTO – BIOS auto configure DISABLE – Disables ASPM.
L1 Substates	Disabled [Default] , L1.1 L1.1 & L1.2	PCI Express L1 Substates settings.
PTM	Disabled [Default] , Enabled	Enable/Disable Precision Time Measurement
PCIe Speed	Auto [Default] Gen1 Gen2 Gen3	Configure PCIe speed

3.6.3.2.1.2 PCI Express Root Port 4(LAN2-I225/I226)

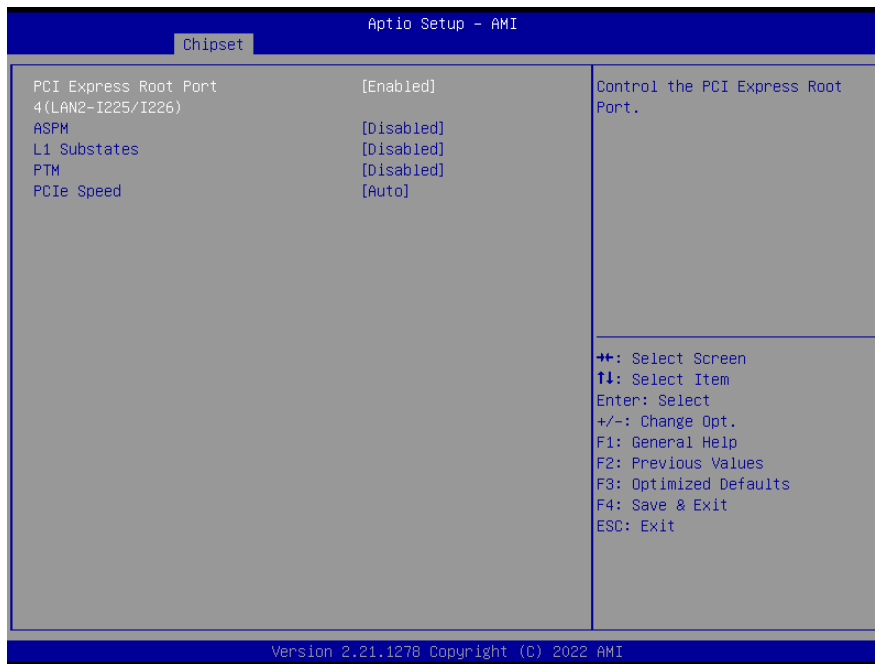

Item	Option	Description
PCI Express Root Port 4 (LAN2-I225/I226)	Disabled Enabled[Default],	Control the PCI Express Root Port.
ASPM	Disabled[Default] L0s L1 L0sL1 Auto	Set the ASPM Level: Force L0s – Force all links to L0s State AUTO – BIOS auto configure DISABLE – Disables ASPM.
L1 Substates	Disabled[Default], L1.1 L1.1 & L1.2	PCI Express L1 Substates settings.
PTM	Disabled[Default], Enabled	Enable/Disable Precision Time Measurement
PCIe Speed	Auto[Default] Gen1 Gen2 Gen3	Configure PCIe speed

3.6.3.2.1.3 PCI Express Root Port 5(M.2 KeyB/IET)

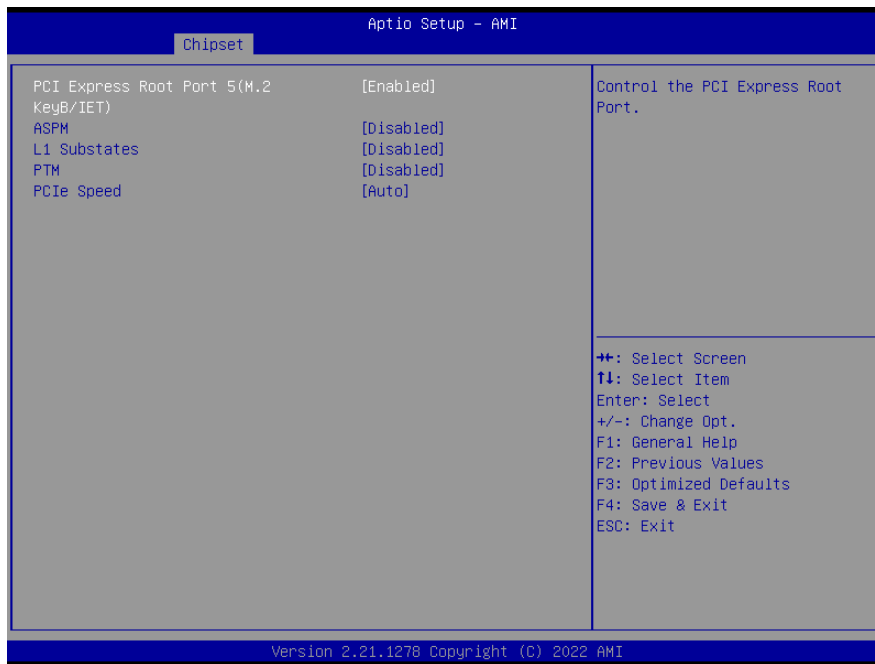

Item	Option	Description
PCI Express Root Port 5(M.2 KeyB/IET)	Disabled Enabled[Default],	Control the PCI Express Root Port.
ASPM	Disabled[Default] L0s L1 L0sL1 Auto	Set the ASPM Level: Force L0s – Force all links to L0s State AUTO – BIOS auto configure DISABLE – Disables ASPM.
L1 Substates	Disabled[Default], L1.1 L1.1 & L1.2	PCI Express L1 Substates settings.
PTM	Disabled[Default], Enabled	Enable/Disable Precision Time Measurement
PCIe Speed	Auto[Default] Gen1 Gen2 Gen3	Configure PCIe speed

3.6.3.2.1.4 PCI Express Root Port 7(M.2 KeyE/IET)

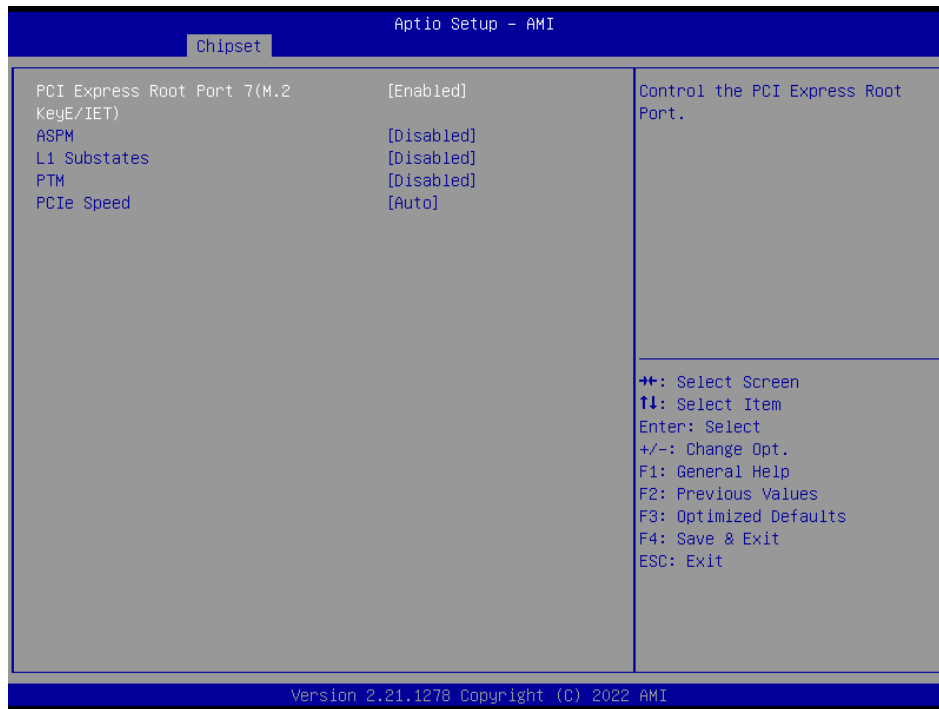

Item	Option	Description
PCI Express Root Port 7(M.2 KeyE/IET)	Enabled[Default], Disabled	Control the PCI Express Root Port.
ASPM	Disabled[Default] L0s L1 L0sL1 Auto	Set the ASPM Level: Force L0s – Force all links to L0s State AUTO – BIOS auto configure DISABLE – Disables ASPM.
L1 Substates	Disabled L1.1 L1.1 & L1.2[Default],	PCI Express L1 Substates settings.
PTM	Disabled[Default], Enabled	Enable/Disable Precision Time Measurement
PCIe Speed	Auto[Default] Gen1 Gen2 Gen3	Configure PCIe speed.

3.6.3.2.2 SATA Configuration

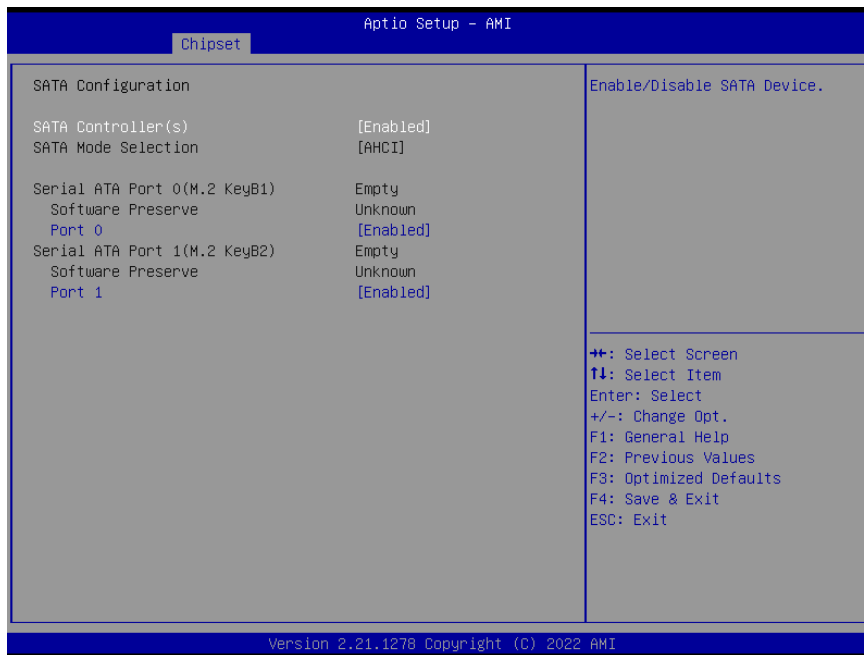

Item	Option	Description
SATA Controller(s)	Enabled[Default] Disabled,	Enable/Disable SATA Device.
Port 0/1	Enabled[Default] Disabled,	Enable or Disable SATA Port.

3.6.3.2.3 USB Configuration

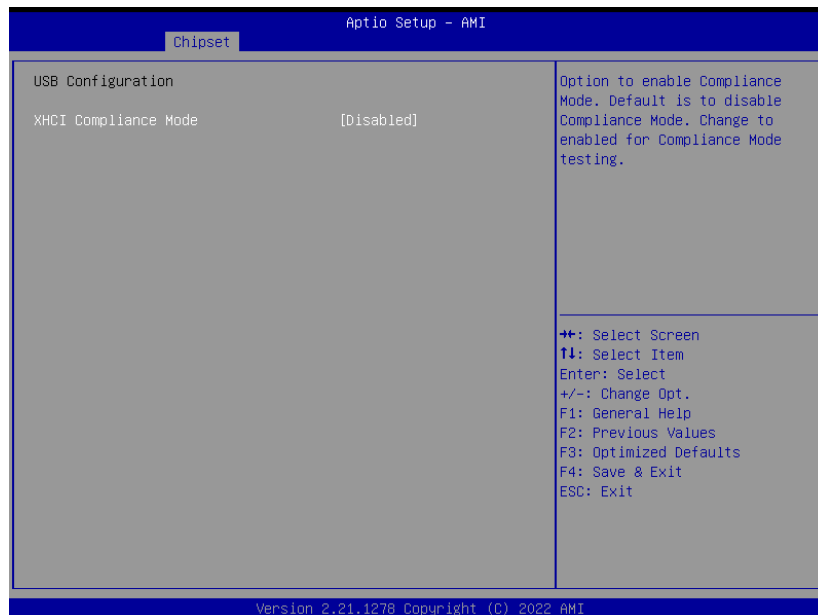

Item	Option	Description
XHCI Compliance Mode	Disabled[Default] Enabled	Option to enable Compliance Mode. Default is to disable Compliance Mode. Change to enabled for Compliance Mode testing.

3.6.3.2.4 HD Audio Configuration

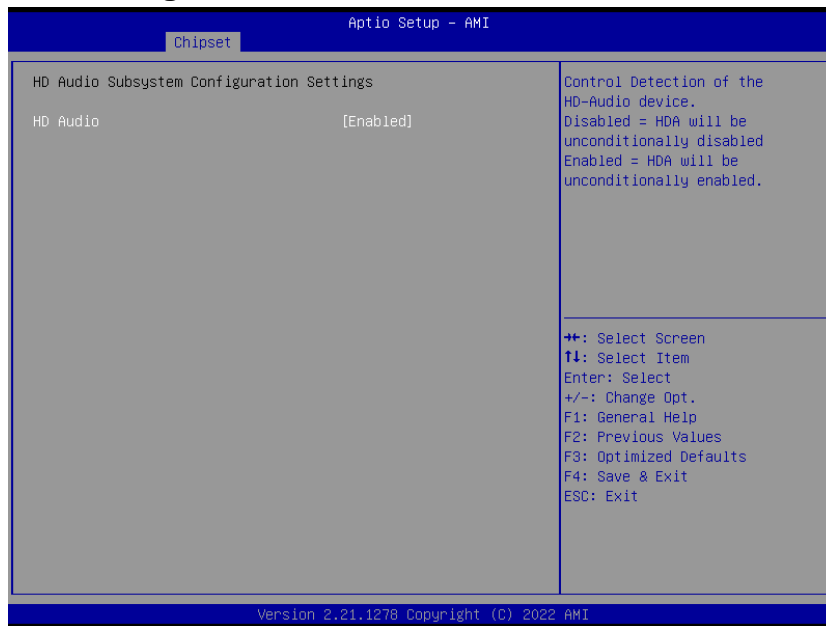

Item	Option	Description
HD Audio	Disabled Enabled[Default],	Control Detection of the HD-Audio device. Disable = HDA will be unconditionally disabled Enabled = HDA will be unconditionally enabled.

3.6.3.2 Board & Panel Configuration



Item	Option	Description
ErP Function	Disabled[Default] Enabled	ErP Function (Deep S5).

EMS-EHL

PWR-On After PWR-Fail	Off[Default] On Last state	AC loss resume.
Wake Up by Ring	Disabled Enabled[Default]	Wake Up by Ring from S3/S4/S5.
Watch Dog	Disabled[Default] 30 sec 40 sec 50 sec 1 min 2 min 10 min 30 min	Select WatchDog.
USB Standby Power	Disabled Enabled[Default]	Enable/Disabled USB Standby Power during S3/S4/S5.
SHOW DMI INFO	Disabled[Default] Enabled	SHOW DMI INFO.

3.6.4 Security

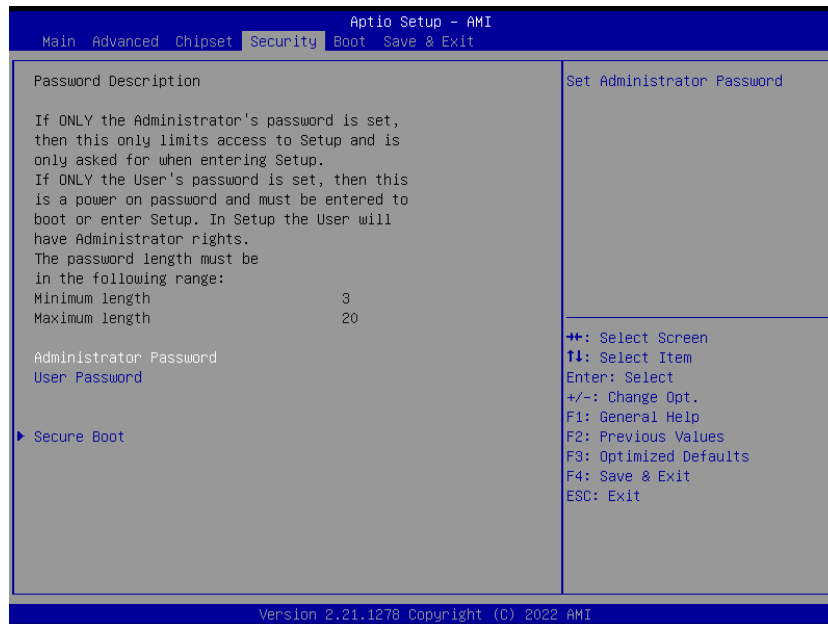

- **Administrator Password**

Set setup Administrator Password

- **User Password**

Set User Password

3.6.4.1 Secure Boot

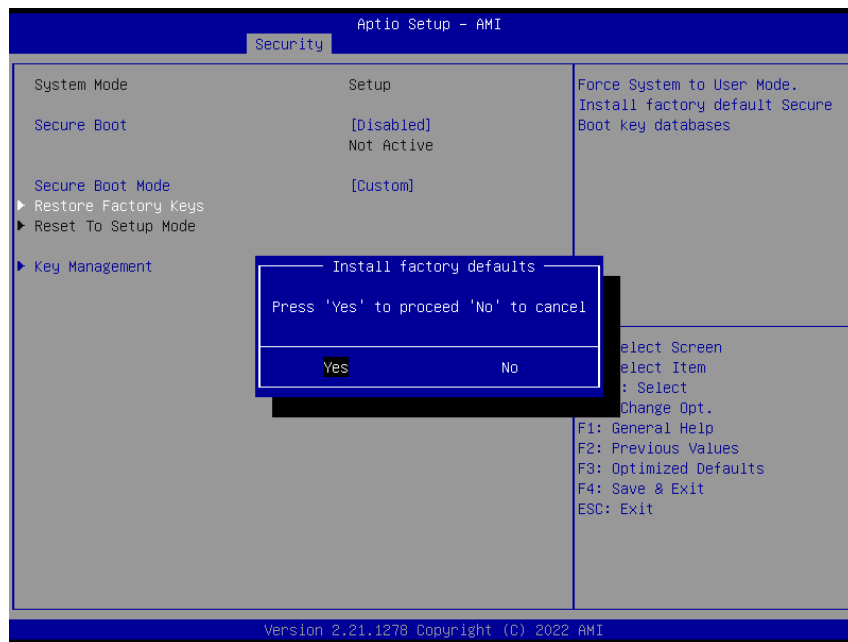

Item	Option	Description
Secure Boot	Disabled[Default] Enabled	Secure Boot feature is Active if Secure Boot is Enabled, Platform Key(PK) is enrolled and the System is in User mode. The mode change requires platform reset.
Secure Boot Mode	Standard Custom[Default]	Secure Boot mode options: Standard or Custom. In Custom mode, Secure Boot Policy variables can be configured by a physically present user without full authentication.

3.6.4.1.1 Key Management

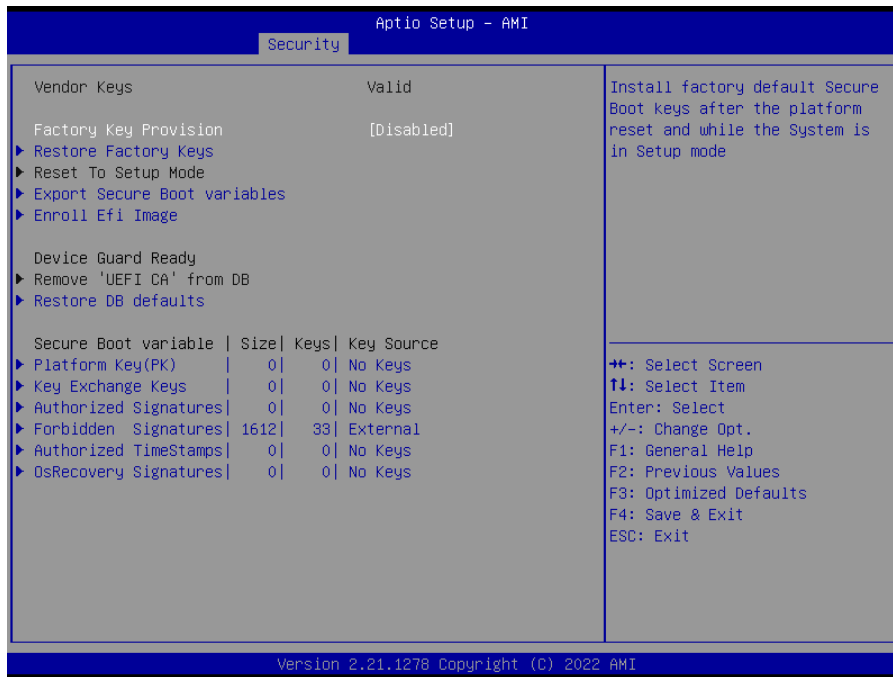

Item	Option	Description
Factory Key Provision	Disabled[Default] Enabled	Install factory default Secure Boot keys after the platform reset and while the System is in Setup mode.

3.6.5 Boot

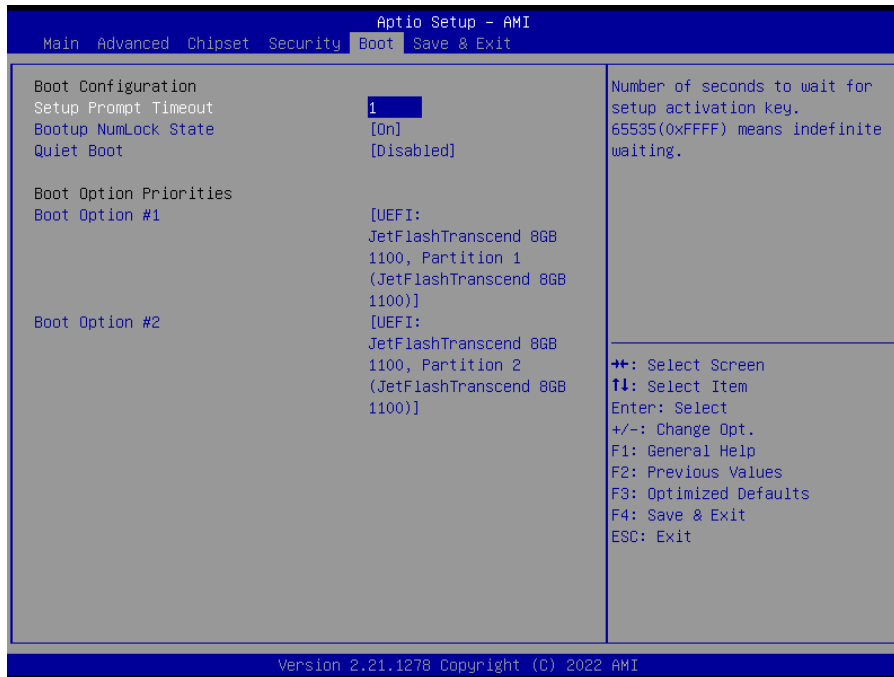

Item	Option	Description
Setup Prompt Timeout	1~ 65535	Number of seconds to wait for setup activation key. 65535(0xFFFF) means indefinite waiting.
Bootup NumLock State	On[Default] Off	Select the Keyboard NumLock state
Quiet Boot	Disabled[Default] Enabled	Enables or disables Quiet Boot option
Boot Option #1/2	Set the system boot order.	

3.6.6 Save and exit

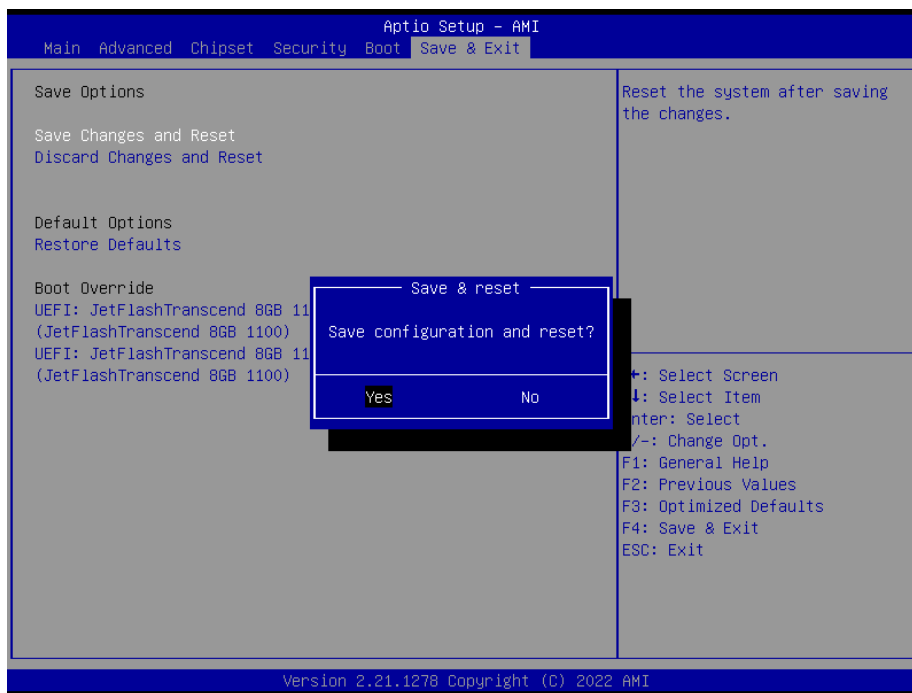
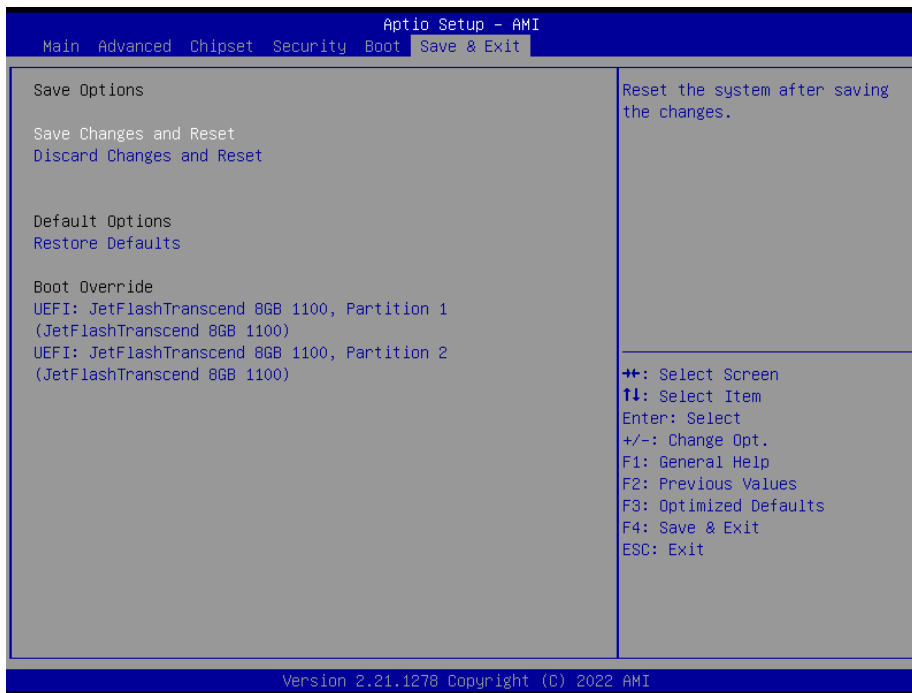

3.6.6.1 Save Changes and Reset

Reset the system after saving the changes.

3.6.6.2 Discard Changes and Reset

Any changes made to BIOS settings during this session of the BIOS setup program are discarded. The setup program then exits and reboots the controller.

3.6.6.3 *Restore Defaults*

This option restores all BIOS settings to the factory default. This option is useful if the controller exhibits unpredictable behavior due to an incorrect or inappropriate BIOS setting.

4. Drivers Installation



Note: Installation procedures and screen shots in this section are for your reference and may not be exactly the same as shown on your screen.

4.1 Install Chipset Driver

All drivers can be found on the Avalue Official Website:

<http://www.avalue.com.tw>.



Note: The installation procedures and screen shots in this section are based on Windows 10 operation system. If the warning message appears while the installation process, click Continue to go on.

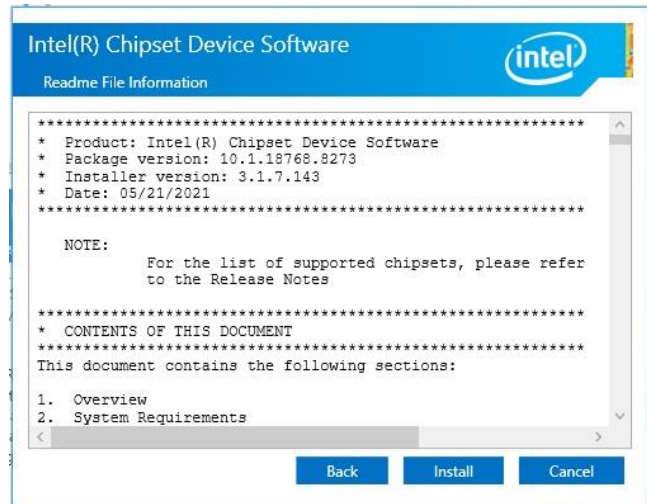

Step 3. Click Install.



Step1. Click Next.



Step 4. Click Finish to complete setup.



Step 2. Click Accept.

4.2 Install ME Driver

All drivers can be found on the Avalue Official Website:

<http://www.avalu.com.tw>.



Note: The installation procedures and screen shots in this section are based on Windows 10 operation system. If the warning message appears while the installation process, click Continue to go on.

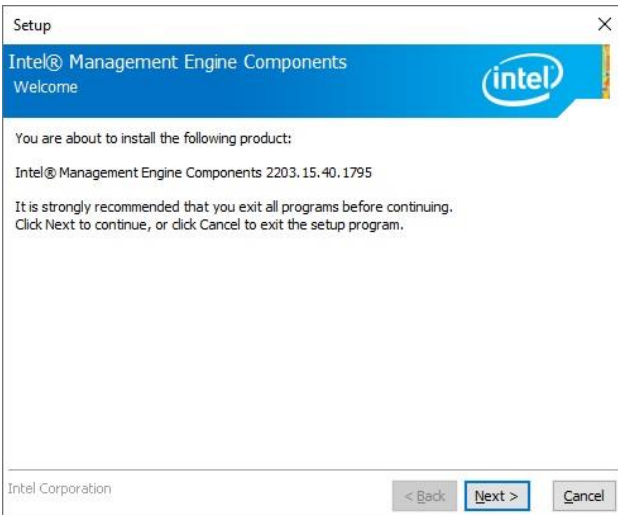

Step1. Click **Next** to start installation.



Step 2. Click **Next**.

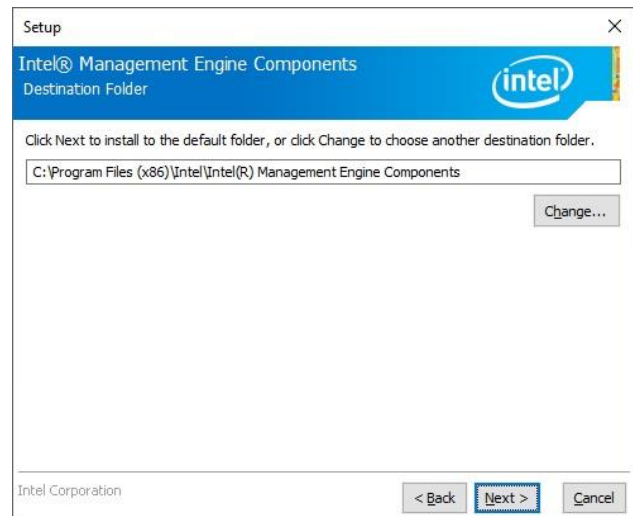

Step 3. Click **Next** to proceed setup.

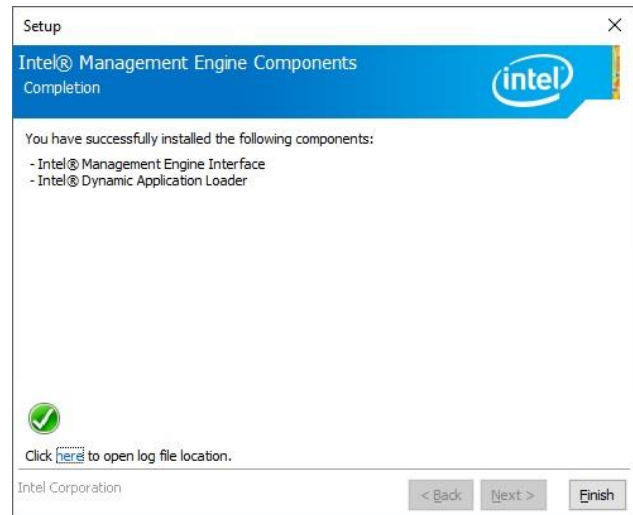

Step 4. Click **Finish** to complete setup.

4.3 Install VGA Driver

All drivers can be found on the Avalue Official Website:

<http://www.avalue.com.tw>.



Note: The installation procedures and screen shots in this section are based on Windows 10 operation system.

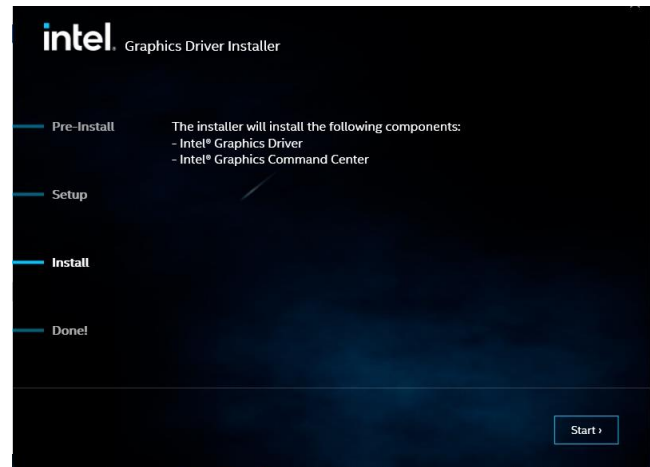

Step 3. Click Start.



Step 1. Click Next to continue installation.

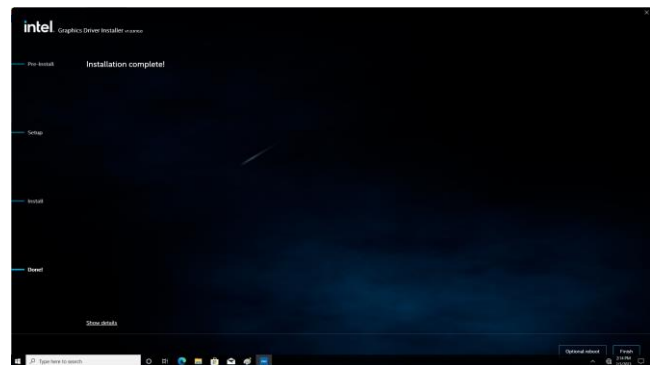

Step 4. Click Finish to complete setup.

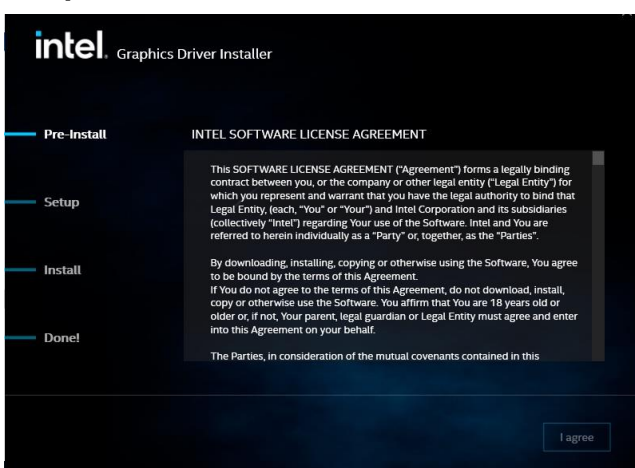

Step 2. Click I agree.

4.4 Install Audio Driver (For Realtek ALC888S)

All drivers can be found on the Avalue Official Website:

<http://www.avalu.com.tw>.



Note: The installation procedures and screen shots in this section are based on Windows 10 operation system.

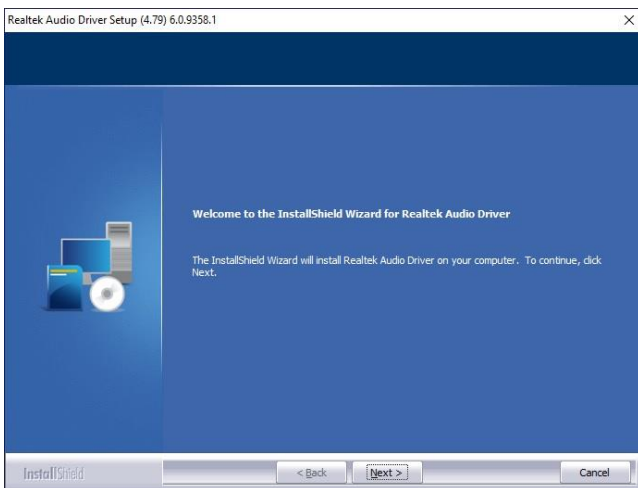

Step 1. Click **Next** to continue setup.

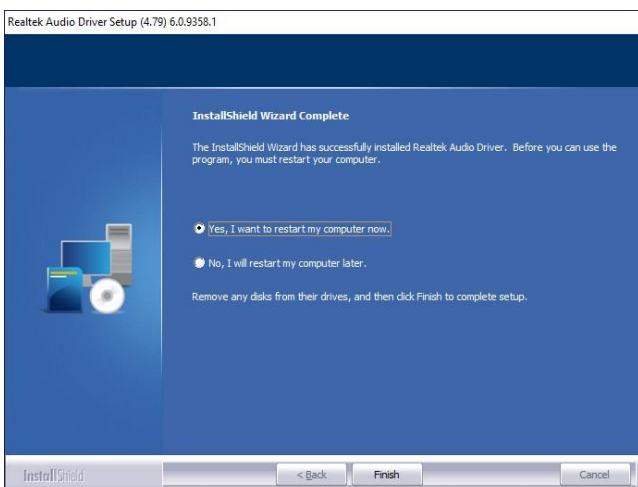

Step 2. Click **Finish** to complete the setup.

4.5 Install Ethernet Driver

All drivers can be found on the Avalue Official Website:

<http://www.avalue.com.tw>.



Note: The installation procedures and screen shots in this section are based on Windows 10 operation system.



Step 3. Click Next.

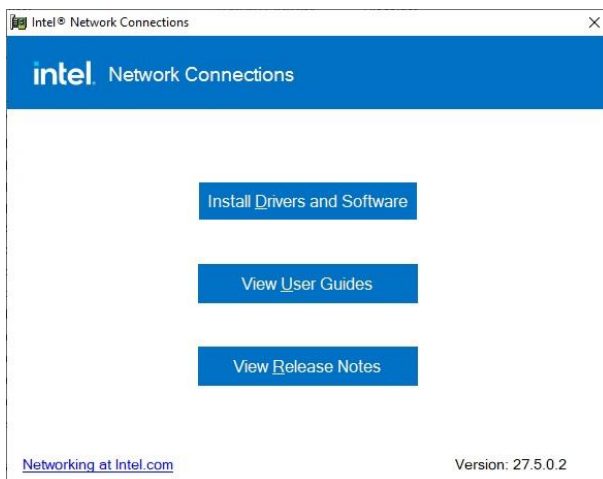

Step 1. Click Install Drivers and Software.

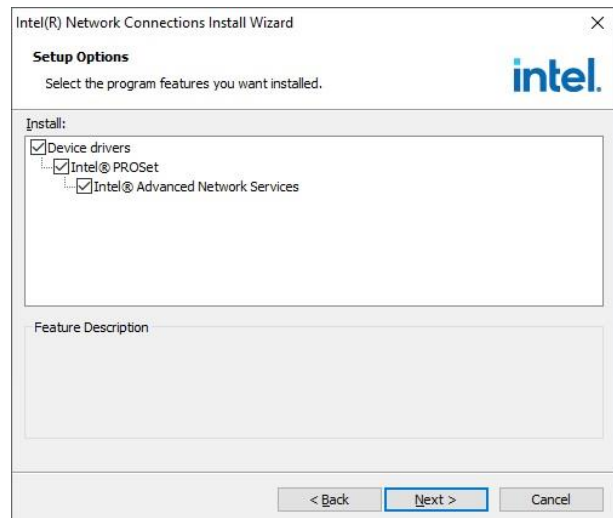

Step 4. Click Next.

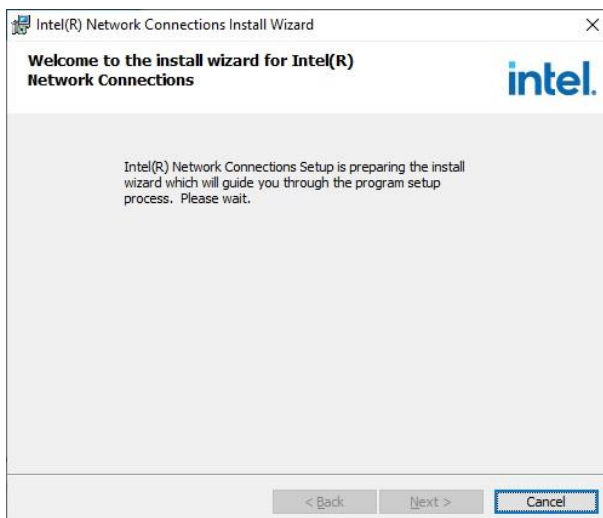

Step 2. Click Next.

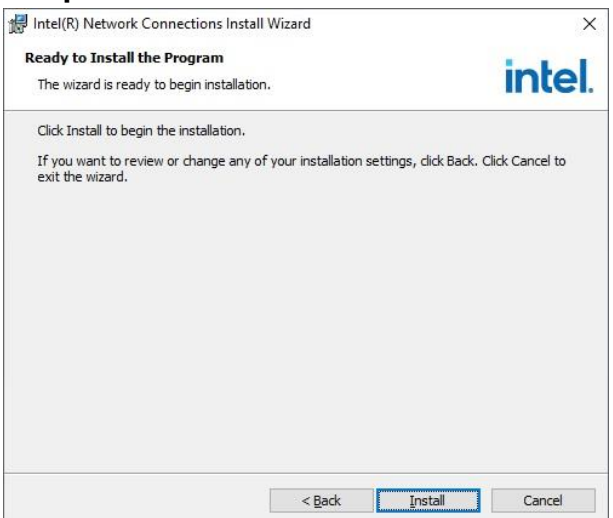

Step 5. Click Install.

EMS-EHL

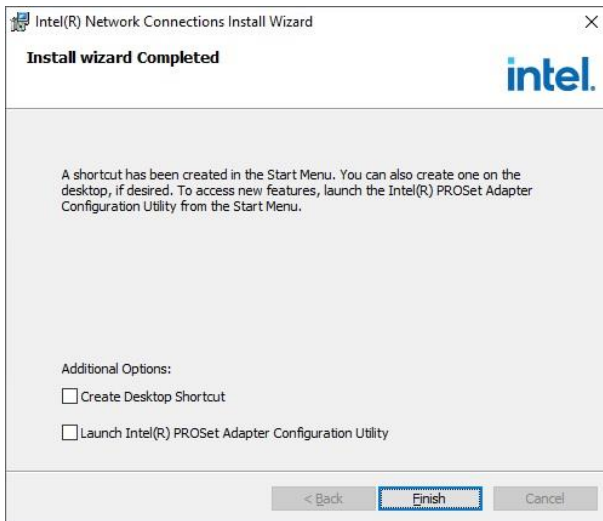

Step 6. Click **Finish** to complete the setup.

